

DDCS-Expert

Standalone Motion Controller Users Manual V1

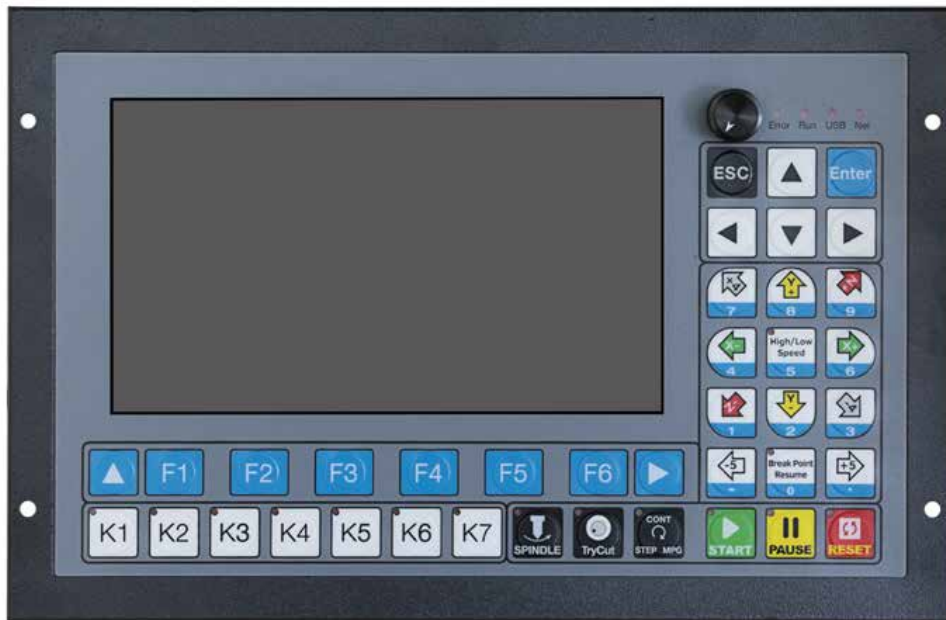

This Manual based on:
Software Version: 2020-09-28
Hardware Version:2020-401-0

All copyrights reserved
Shall not be reproduced without permission.

深圳市众联拓数控科技有限公司
Shenzhen Digital Dream Numerical Technology Co., Ltd.

Contents

1	DDCS-Expert Brief Introduction	3
1.1	Product Brief Introduction	3
1.2	DDCS-Expert Brief technical feature	4
1.3	Appearance, Structure and Size of Product	5
1.4	Explanation of Abbreviations	7
2	Controller Panel and Operation	8
3	Input and Output Ports	10
4	Wiring	15
4.1	Wiring Board Overview	15
4.2	Power Supply Input	18
4.3	Spindle Wiring	20
4.3.1	Analog Spindle	20
4.3.2	Servo Spindle (PLUSE/DIRECTION)	22
4.3.3	Multi-Speed Spindle	22
4.3.4	Relay Wiring	24
4.4	Stepper /Servo Driver Wiring	25
4.5	Limit, Home and Probe Inputs	27
4.6	External Buttons	29
4.7	MPG Wiring	29
4.8	Series Port Wiring	20
5	Software and Monitor	33
5.1	The Main Page of the software	34
5.1.1	FRO	38
5.1.2	SRO	38
5.1.3	SJR/Jog Step	39
5.1.4	Feed Rate	41
5.1.5	Analog S/Servo S/Multi-Speed	43
5.2	Simulation	46
5.3	Probe	49
5.3.1	Floating Probe	49

5.3.2	Fixed Probe	51
5.4	Go work Zero	53
5.5	Go Home	54
5.6	Clear	57
5.7	Break Run (Breakpoint Resume)	58
5.8	Manual	60
5.9	Coord Set	62
5.9.1	Select Coord	63
5.9.2	Clear X / Y / Z / 4th / 5th A xis	64
5.9.3	Set Z Step	65
5.1.9.4	Deeper and Move up	65
5.10	MDI	66
5.11	Middle	69
5.11.1	Find Middle Point in X Axis	70
5.11.2	Find Middle Point in Y Axis	72
5.11.3	Find a middle point f or the Arc	74
5.12	Work Record	78
5.13	Sort Process	80
6	Program	82
7	Parameters	85
7.1	Parameters List and Details	85
7.2	Search the Parameters by the Number	100
7.3	Parameter Setting Backup	102
7.4	Parameters Restore	103
8	System Info	105
8.1	Registration	106
8.2	Password Setting	109
8.3	System Update (System Software Update)	111
8.4	System Set	114
8.4.1	System Time Setting	114
8.4.2	Set IP Address manually by Ethernet Cable	116
8.5	System BackUp	131
9	G Code and M Code	132

The copyright of this manual belongs to Shenzhen Digital Dream Numerical Technology Co., Ltd. (herein after referred as Digital Dream Company). This manual and any image, table, data or other information contained in this manual may not be reproduced, transferred, or translated without any prior written permission of Digital Dream Company.

The information contained in this manual is constantly being updated. You can login to the official website of Digital Dream Company www.ddcnc.com to download the latest PDF edition for free.

1 DDCS-Expert Brief Introduction

1.1 Product Brief Introduction

Thank you for your interest in our standalone motion controller and for taking the time to read this manual.

Digital Dream is a numerical control company specializing in the research, development and production of various CNC (Computer Numerical Control) systems since 2008. Digital Dream aims to combine high quality and high reliability with affordability.

The DDCS Expert is a 3~5 axes motion controller for open or close stepper and servo systems with 7/10.2 full color display screen. The highest output pulse per axis is 1MHz. The users can self-define the functional keys. This controller supports multiple spindle mode, support straight Tool Magazine, gantry type Magazine, disk type magazine. The Operation system interface even though very comprehensive, can be learned in very short time.

The DDCS Expert numerical control system adopts the ARM+FPGA design framework. ARM controls the human-computer interface and code analysis and the FPGA provides the underlying algorithms and creates the control pulse. This guarantees reliable control and easy operation. The internal operating system is Linux based.

The DDCS Expert can be used for many styles and types of CNC machines. Lathes, Routers, Pick&Place and Mills, lathe and cutters are just a few examples. The DDCS Expert operates as a Stand Alone system without the need of a computer. This guarantees high precision, accuracy and reliability.

1.2 DDCS-Expert Brief technical feature:

- 1) Max. 5 Axis; 1M Hz output frequency for each axis; 2-4 Axis linear interpolation, any 2 axis circular interpolation;
- 2) 7 inch full color display screen; resolution ratio: 1024*600, 40 operation keys;
- 3) 24 photoelectric isolated digital inputs, 21 photoelectric isolated digital outputs;
- 4) Analog spindle control 0-10V spindle control, also support PWM Output;
- 5) Magazine type: Supports multiple spindle mode, support straight Tool Magazine, gantry type Magazine, disk type magazine;
- 6) Probe Mode: Support Floating Probe and Fixed Probe;
- 7) Backlash compensation methods: direction gap compensation, radius gap compensation, length compensation;
- 8) Interpolation Algorithm: S type, circular hard algorithm, circular soft algorithm;
- 9) Language: Chinese, English;
- 10) Software Alarms: Program Error, operation Error, overtravel Error, Driver Error and so on;
- 11) Network: Support file share and online machining the remote files by Ethernet;
- 12) Spindle control mode support Multi-speed (3 lines 8 kinds speed), 0-10V Analog output, and servo spindle output;
- 13) Compatible with standard G-code, support popular CAD/CAM software, such as ArtCam, MasterCam, ProE, JDSoft SurfMill, Aspire, Fusion 360 and so on;
- 14) The control system can preview the processing path before machining, and it makes the system more steady, working smoothly and precise;
- 15) Support high speed machining in continuous Polyline segment, system can choose a most efficient algorithm automatically from different kinds Polyline segment algorithm;
- 16) Support un-limited size file for machining;
- 17) Support Pause Breakpoint resume, "Power Cut" recovery, Start from the specific line;
- 18) Support time-lock function;
- 19) Support 4 kinds operation rights: visitor, operator, admin, super admin;
- 20) Support function of "Try cutting" (handwheel guiding) and "Single-stage processing mode" and so on;
- 21) Support the function of Back to original point
- 21) The Power Supply for the controller is 24VDC, minimum Current is 0.5A;
- 22) The Power Supply for IO Port is 24VDC, minimum current is 0.5A; By the IO power supply, system already supply the power to IO ports. So no need the external power supply.

1.3 Appearance, Structure and Size of Product

The DDCS-Expert is a small box that can fit in a window of a small control box or control cabinet. Four locking hooks fix this controller from the frame. The dimension you find in Figure 1-1 and Figure 1-2.

The front panel is 268mm*172.5mm*5.2mm;

The main body is 268mm*172.5mm*70mm;

To mount the unit in an equipment cabinet, cut the hole 258.4mm*109mm

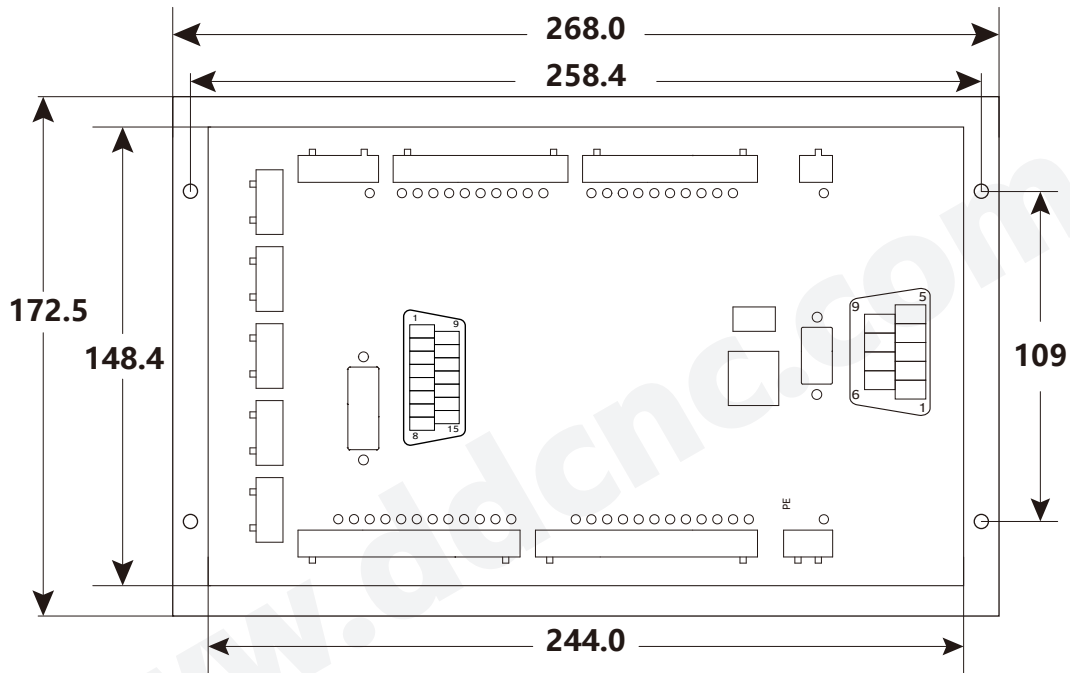

Figure 1-1 DDCS-Expert(DDCSE) Back view and dimensions

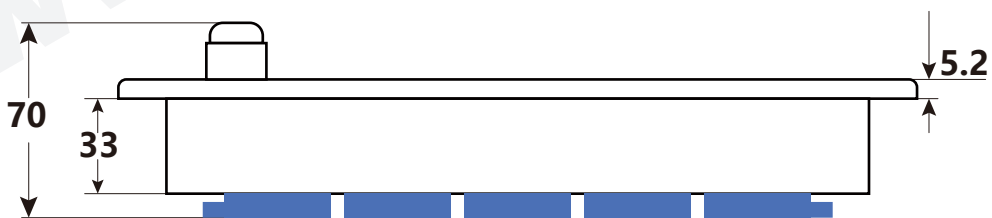

Figure 1-2 (DDCSE) Side view and dimensions

The front panel consists of 40 user keys and the 7 inch (1024*600) LCD.



Figure 1-3 Front panel

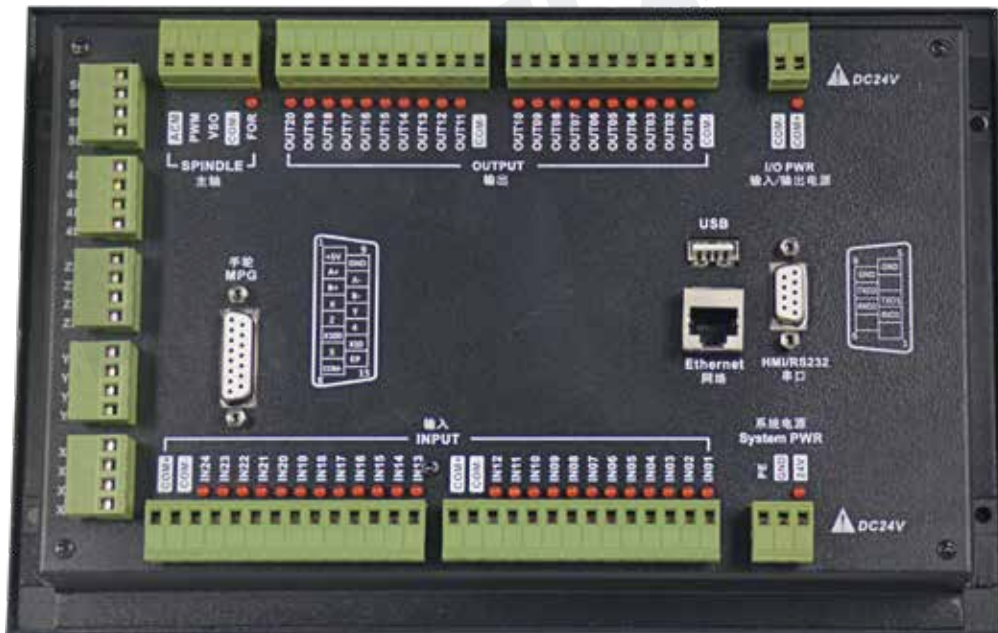

Figure 1-4 Back Side of the controller

The only accessories is the USB extended cable.



Figure 1-5 USB extended cable

1.4 Explanation of Abbreviations

When operating the DDCS, the users will come across some English abbreviations. Here a list with explanations:

FRO: Feed Rate Override

SRO: Spindle Rate Override

SJR: Jog Speed Setting

F: Feed rate, unit is mm/min

S: Spindle Speed, unit rev/min.

X: The coordinate code of the X axis.

Y: The coordinate code of the Y axis.

Z: The coordinate code of the Z axis.

A: The coordinate code of the A axis

B: The coordinate code of the B axis

BUSY: The system is busy. You still can adjust FRO and SRO

READY: READY mode, any operation can be done

RESET: Reset mode, controller is in "OFF" mode, no operation can be performed

CONT: Continuous mode, each axis can be manually jogged with the arrow keys

Step :Manual Step Mode, each axis can be jogged in defined steps

MPG: MPG mode. Operate the machine with the MPG (Manual Pulse Generator)

BUSY: Run G code. Auto is showing when file is processing

1.5 Notes and Warnings



Keep away from exposure to moisture or water. This product contains sophisticated electronics and must not get wet.

Wiring warning: the IO input terminal of this controller supports equipment with source power (such as Inductive Proximity Switch). When using this kind of equipment, pay attention to the polarity. Avoid the +terminal to be connect with GND. This controllers has analog output for spindle control (0-10V). Please avoid this terminal to ever connect with GND as damage to the controller may occur.



Operation warning. Please observe all security measures when operating the machine. The ESTOP must be connected and properly labelled. In case of a problem, press the E-stop at once to avoid damage to humans, animals and the equipment.



High voltage danger. The DDCS is connected to 24V DC. Obey and follow the electricity safety rules of your country when connecting this equipment.

2 Controller Panel and Operation

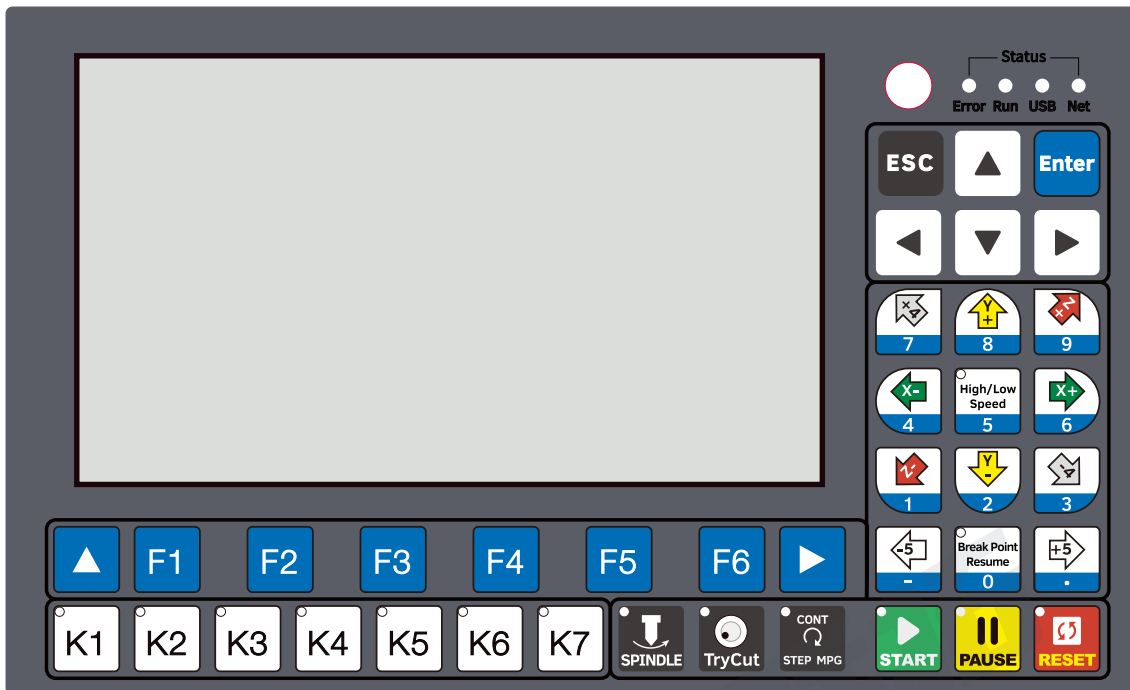

Figure 2-1 DDCS-Expert (DDCSE) Controller Panel

Keys Icon	Definition	Notes
	Return to previous menu	In the software, press the key to return to previous menu.
	Go to Next Page	In the software, press the key to the next page of the sub-menus.
	Sub-menu key F1~ F6	Sub-menu keys need to work according with the controller software.
	Extend function key K1~ K7	In the Para Page, the users can define K1-K7 Keys.
	Spindle manual start/close	Press this key to manually switch the spindle on or off. Can not be used if Reset is blinking and while processing an operation (Busy) When the LED lights up, then the spindle start.
	Try cut Enable/Disable	Press this key to Enable or Disable the Try-Cut (Handwheel guiding) function.
	Mode switch	When in READY, this key changes the Jog mode from Continuous to Step and MPG control.
	Start operation	After loading the G code file, please press this key to start the operation. In case of Pause Status, press this key to continue the processing operation.
	Pause operation	Press this key to Pause the operation.
	Reset and E-STOP	If Reset is blinking, press this key to activate the controller again. Press this key to stop the programming urgently.

Keys Icon	Definition	Notes
	1: Cursor moves quickly 2: Ratio/Values increase or decrease 3: Push to Enter	In the Monitor Page, by turning the knob, it can move among different column; after selecting the column, we can adjust the values fast and easily; In the Program page, by turning the knob, we can select files quickly and press it to confirm; In the Parm and IO page, it also have the same functions.
	1: Cursor moves Up 2: Parameter value increases 3: Highlight the Selections	In Monitor, the key can highlight the processing parameters FRO/SRO/SJR and so on; In Program/Param/IO page, it highlight the selections.
	1: Cursor moves Down 2: Parameter value decreases 3: Highlight the Selections	In Monitor, the key can highlight the processing parameters FRO/SRO/SJR and so on; Program/Param/IO page, it highlight the selections.
	1: Cursor moves Left 2: Moves through Para Kinds	In Param Page, the key moves among the Para Kinds; In IO page, It moves the cursor left.
	1: Cursor moves Right 2: Switch through Para Kinds	In Param Page, the key moves among the Para Kinds; In IO page, It moves the cursor right.
	1: BackSpace Key 2: Cancel or Delete Key	By it we can come back to the main page, cancel and delete the value input, cancel the current action and so on.
	1: Confirm and Enter key	In "CONT Mode", the X axis will Continuously move positive after pressing this key. In "STEP Mode" X will move positive in steps.
	1: X axis moves right; 2: Number "6".	In "CONT Mode", the X axis will Continuously move positive after pressing this key. In "STEP Mode" X will move positive in steps.
	1: X axis moves left; 2: Number "4".	In "CONT Mode", the X axis will Continuously move negative after pressing this key. In "STEP Mode" X will move negative in steps.
	1: Y axis moves forward; 2: Number "8".	In "CONT Mode", the Y axis will continuously move positive after pressing this key. In "STEP Mode" Y will move positive in steps.
	1: Y axis move backward; 2: Number "2".	In "CONT Mode", the Y axis will continuously move negative after pressing this key. In "STEP Mode" Y will move negative in steps.
	1: Z axis Up 2: Number "9".	In "CONT Mode", the Z axis will continuously move positive after pressing this key. In "STEP Mode" Z will move positive in steps.
	1: Z axis down 2: Number "1".	In "CONT Mode", the Z axis will continuously move negative after pressing this key. In "STEP Mode" Z will move negative in steps.
	1: The 4th Axis rotates in forward direction 2: Number "7".	In "CONT Mode", the 4th axis will continuously move positive after pressing this key. In "STEP Mode" it will move positive in steps.
	1: The 4th Axis rotates in inversion direction 2: Number "3".	In "CONT Mode", the 4th axis will continuously move negative after pressing this key. In "STEP Mode" it will move negative in steps.
	1: The 5th Axis in forward direction 2: The Symbol "-".	In "CONT Mode", the 5th axis will continuously move positive after pressing this key. In "STEP Mode" it will move positive in steps.
	1: The 5th Axis in inversion direction 2: The Symbol ".".	In "CONT Mode", the 5th axis will continuously move negative after pressing this key. In "STEP Mode" it will move negative in steps.
	1: High or Low Speed selection 2: Number "5".	When the LED lights up, it is in high-speed mode.
	1: Breakpoint resume active 2: Number "0".	When the LED lights up, the breakpoint resume is active.

3 Input and Out Ports

DDCS-Expert controller creates a self-defined IO ports method. According to the user's favorite, the users can define the input and output ports as which they want. In the IO page, the users can define the input port and output port, and also can inspect the input/output port and MPG status.

Power on the DDCS-Expert controller, system popup the main page, and press F4 Key to go to the IO Port Page:

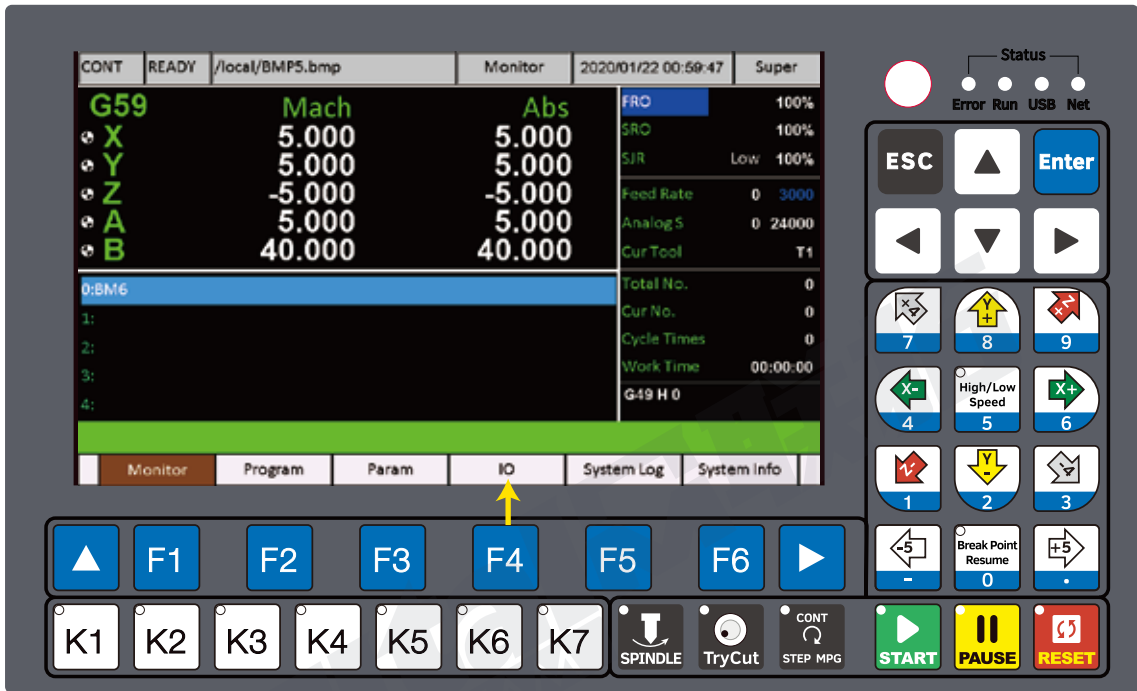

Figure 3-1 Press F4 to IO Page

Page of the IO pop up as below. In the page, you can use the Up/Down arrow, Right/Left arrive and Knob to select and change the settings.

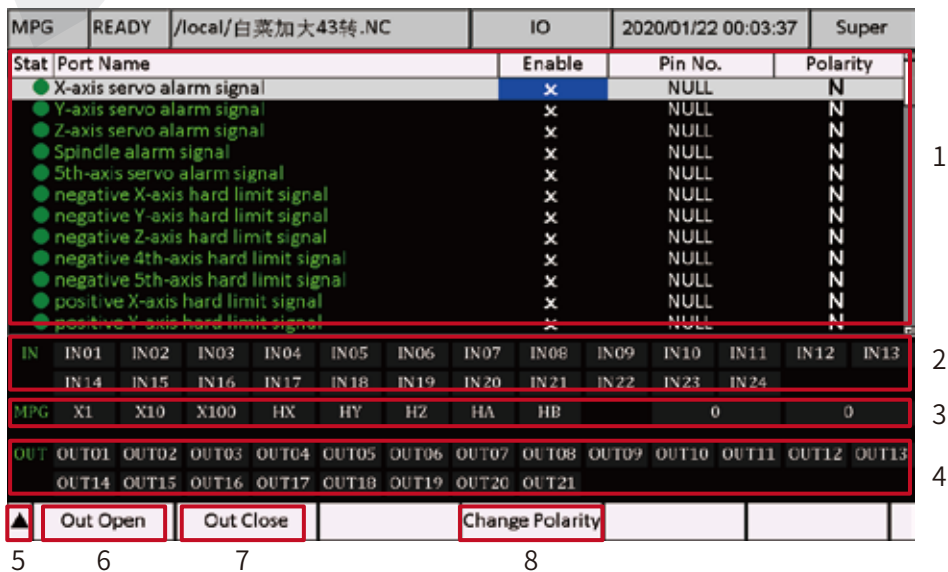

Figure 3-2 IO Page

Column 1: The input and output port definitions:

Status	Port Name	Enable	Pin No.	Polarity
● or ●	X-axis servo alarm signal	X or √	NULL or IN01-IN24	N or p
	Y-axis servo alarm signal			
Green: Means the status is not active.	Z-axis servo alarm signal	X: Means the signal is disabled.	NULL: No definition.	N: Negative pole
	Spindle alarm signal			
	5th-axis servo alarm signal			
Red: Means the status is active.	Negative X-axis hard limit signal	√: Means the signal is enabled.	IN01-IN24: Input port 1 to Input port 24	P: Positive pole
	Negative Y-axis hard limit signal			
	Negative Z-axis hard limit signal			
	Negative 4th-axis hard limit signal			
	Negative 5th-axis hard limit signal			
	Positive X-axis hard limit signal			
	Positive Y-axis hard limit signal			
	Positive Z-axis hard limit signal			
	Positive 4th-axis hard limit signal			
	Positive 5th-axis hard limit signal			
	X-axis Zero Signal			
	Y-axis Zero Signal			
	Z-axis Zero Signal			
	4th-axis Zero Signal			
	5th-axis Zero Signal			
	Floating Probe signal			
	Fixed Probe signal			
	External key 1			
	External key 2			
	External key 3			
External key 4				
External key 5				
External key 6				
External Start				
External Pause				
External Estop				
Spindle Stop Signal (M300)				
Tool release input signal (M301)				
Tool lock input signal (M302)				
Tool open input signal (M303)				
Dust cover open/close input signal (M305/M306)				
Inverter Alarm input signal				
Customs alarm input signal 1				
Customs alarm input signal 2				
Customs alarm input signal 3				
Customs alarm input signal 4				
Customs alarm input signal 5				
Tool close input signal (M304)				

Status	Port Name	Enable	Pin No.	Polarity
● or ●	Spindle forward rotation control signal	X or √	NULL or OUT01-OUT21	N or p
	Spindle reverse rotation control signal			
Green: Means the status is not active.	Spindle section speed 1	X: Means the signal is disabled.	NULL: No definition.	N: Negative pole
	Spindle section speed 2			
	Spindle section speed 3			
Red: Means the status is active.	M8/M9 control signal	√: Means the signal is enabled.	OUT1-OUT24: Output port 1 to output 21	P: Positive pole
	M10/M11 control signal			
	System alarm signal			
	System Running signal			
	System Brake signal			
	System ready signal			
	Tool release/lock signal (M154/M155)			
	Tool launch/retract signal (M152/M153)			
	Front positioning/off signal (M156/M157)			
	Vacuum pump on/off output signal (M158/M159)			
	Dust cover open/close output signal (M150/M151)			
	Push cylinder open/close output signal (M160/M161)			
	Vacuum cleaner on/off output signal (M162/M163)			
	Left positioning on/off output signal (M164/M165)			
	Vacuum valve open/close output signal (M166/M167)			
	Multi-process 1 Open/close output signal (M168/M169)			
	Multi-process 2 Open/close output signal (M170/M171)			
Multi-process 3 Open/close output signal (M172/M173)				
Multi-process 4 Open/close output signal (M174/M175)				
Cooling 1 on/off output signal (M176/M177)				
Cooling 1 on/off output signal (M178/M179)				

Important:

In the controller default setting, we already define the Output port 21 as the “Spindle forward rotation control”. On the controller wiring board, we didn’t name it as “Out21”, we name it as “FRO”.

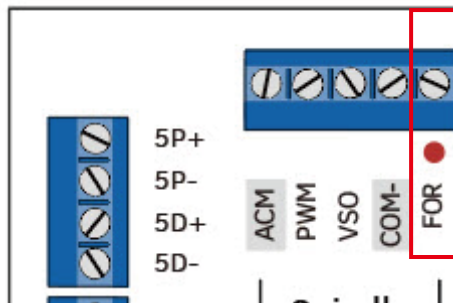

Figure 3-3 FOR Output Port

Column 2 and Column 4:

Show the input ports or output ports are on the short-circuit or not.

If the little block becomes Red,the according port is on the short-circuit; if it' s still black,the according port is not on the short-circuit.

For example, we define the IN01 as the “X-axis Zero Signal”, and when the X axis touched the limited switch, it will show as below:

CONT	READY	/local/BMP1.bmp	IO	2020/01/22 03:37:34	Guest								
Stat	Port Name			Enable	Pin No.	Polarity							
	● positive X-axis hard limit signal			x	NULL	N							
	● positive Y-axis hard limit signal			x	NULL	N							
	● positive Z-axis hard limit signal			x	NULL	N							
	● positive 4th-axis hard limit signal			x	NULL	N							
	● positive 5th-axis hard limit signal			x	NULL	N							
	● X-axis zero signal			✓	IN01	N							
	● Y-axis zero signal			✓	IN02	N							
	● Z-axis zero signal			✓	IN03	N							
	● 4th-axis zero signal			✓	IN04	N							
	● 5th-axis zero signal			✓	IN05	N							
	● Floating Probe signal			x	NULL	N							
	● Fixed Probe signal			x	NULL	N							
IN	IN01	IN02	IN03	IN04	IN05	IN06	IN07	IN08	IN09	IN10	IN11	IN12	IN13
	IN14	IN15	IN16	IN17	IN18	IN19	IN20	IN21	IN22	IN23	IN24		
MPG	X1	X10	X100	HX	HY	HZ	HA	HB		0			15
OUT	OUT01	OUT02	OUT03	OUT04	OUT05	OUT06	OUT07	OUT08	OUT09	OUT10	OUT11	OUT12	OUT13
	OUT14	OUT15	OUT16	OUT17	OUT18	OUT19	OUT20	OUT21					
▲	Out Open	Out Close					Change Polarity						

Figure 3-4 Input 01 is conducting with COM-

But,the status is active, doesn' t mean that the according signal is active. For example,we reverse the signal' s polarity, and moves the X axis away from the limit switch, the status light and IO block show as below: the X-axis zero signal is active,and IN01 Block is not on,because IN01 is not conducting with COM-.

CONT	READY	/local/BMP0.bmp	IO	2020/01/22 03:52:30	Super								
Stat	Port Name			Enable	Pin No.	Polarity							
	● positive X-axis hard limit signal			x	NULL	N							
	● positive Y-axis hard limit signal			x	NULL	N							
	● positive Z-axis hard limit signal			x	NULL	N							
	● positive 4th-axis hard limit signal			x	NULL	N							
	● positive 5th-axis hard limit signal			x	NULL	N							
	● X-axis zero signal			✓	IN01	P							
	● Y-axis zero signal			✓	IN02	N							
	● Z-axis zero signal			✓	IN03	N							
	● 4th-axis zero signal			✓	IN04	N							
	● 5th-axis zero signal			✓	IN05	N							
	● Floating Probe signal			x	NULL	N							
	● Fixed Probe signal			x	NULL	N							
IN	IN01	IN02	IN03	IN04	IN05	IN06	IN07	IN08	IN09	IN10	IN11	IN12	IN13
	IN14	IN15	IN16	IN17	IN18	IN19	IN20	IN21	IN22	IN23	IN24		
MPG	X1	X10	X100	HX	HY	HZ	HA	HB		0			15
OUT	OUT01	OUT02	OUT03	OUT04	OUT05	OUT06	OUT07	OUT08	OUT09	OUT10	OUT11	OUT12	OUT13
	OUT14	OUT15	OUT16	OUT17	OUT18	OUT19	OUT20	OUT21					
▲	Out Open	Out Close					Change Polarity						

Figure 3-5 The status is active but IN01 is not ON

Here we move the X axis to touch the limit switch, but status light doesn't light up. So the Status shows the signal is active or not, the IN01-IN24 Block shows the port is conducting or not.

CONT	READY	/local/BMP0.bmp	IO	2020/01/22 03:52:25	Super								
Stat	Port Name				Enable	Pin No.	Polarity						
●	positive X-axis hard limit signal				x	NULL	N						
●	positive Y-axis hard limit signal				x	NULL	N						
●	positive Z-axis hard limit signal				x	NULL	N						
●	positive 4th-axis hard limit signal				x	NULL	N						
●	positive 5th-axis hard limit signal				x	NULL	N						
●	X-axis zero signal				✓	IN01	P						
●	Y-axis zero signal				✓	IN02	N						
●	Z-axis zero signal				✓	IN03	N						
●	4th-axis zero signal				✓	IN04	N						
●	5th-axis zero signal				✓	IN05	N						
●	Floating Probe signal				x	NULL	N						
●	Fixed Probe signal				x	NULL	N						
IN	IN01	IN02	IN03	IN04	IN05	IN06	IN07	IN08	IN09	IN10	IN11	IN12	IN13
MPG	X1	X10	X100	HX	HY	HZ	HA	HB		0			15
OUT	OUT01	OUT02	OUT03	OUT04	OUT05	OUT06	OUT07	OUT08	OUT09	OUT10	OUT11	OUT12	OUT13
▲	Out Open	Out Close					Change Polarity						

Figure 3-6 The Signal is not active but port in conducting

Column 3:

Shows MPG setting status. As the following figure shows, the MPG current setting is X10, in Y axis; “-54” block is the calculator of wheels turning step; “0” block shows the the current cursor position.

MPG	READY	23232.txt	IO	2000/12/22 05:13:56	Guest								
Stat	Port Name				Enable	Pin No.	Polarity						
●	X-axis servo alarm signal				x	NULL	N						
●	Y-axis servo alarm signal				x	NULL	N						
●	Z-axis servo alarm signal				x	NULL	N						
●	Spindle alarm signal				x	NULL	N						
●	5th-axis servo alarm signal				x	NULL	N						
●	negative X-axis hard limit signal				x	NULL	N						
●	negative Y-axis hard limit signal				x	NULL	N						
●	negative Z-axis hard limit signal				x	NULL	N						
●	negative 4th-axis hard limit signal				x	NULL	N						
●	negative 5th-axis hard limit signal				x	NULL	N						
●	positive X-axis hard limit signal				x	NULL	N						
●	positive Y-axis hard limit signal				x	NULL	N						
IN	IN01	IN02	IN03	IN04	IN05	IN06	IN07	IN08	IN09	IN10	IN11	IN12	IN13
MPG	X1	X10	X100	HX	HY	HZ	HA	HB		-54			0
OUT	OUT01	OUT02	OUT03	OUT04	OUT05	OUT06	OUT07	OUT08	OUT09	OUT10	OUT11	OUT12	OUT13
▲	Out Open	Out Close					Change Polarity						

Figure 3-7 MPG Input Page

- Column 6: Open the output signal;
- Column 7: Close the output signal;
- Column 8: Change the Polarity to the reverse.

So now we finished the introduction on the IO port. Only when the users understand how to set the IO port and how to inspect the IO page, it will help us on Wiring.

4 Wiring

4.1 Wiring Board Overview

DDCS-Expert wiring board, there are about 7 parts as following:

- 1) System Power and IO Power supply input Ports;
- 2) Driver Signal output Ports;
- 3) Input and Output Ports;
- 4) Spindle Output Ports;
- 5) MPG Port;
- 6) Ethernet and USB interface;
- 7) HMI/RS232 interface.

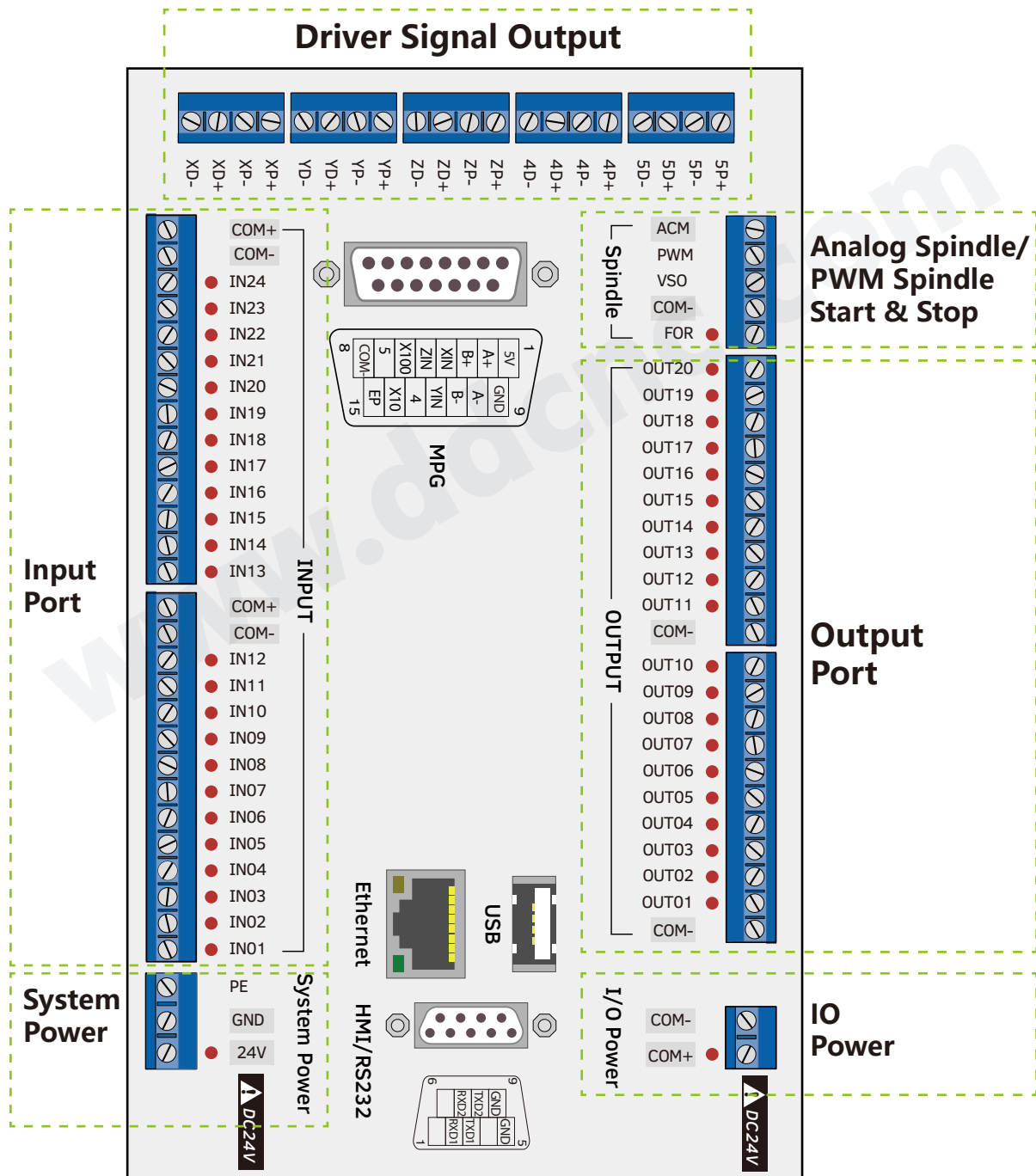

Figure 4-1 Controller Wiring Ports Overview

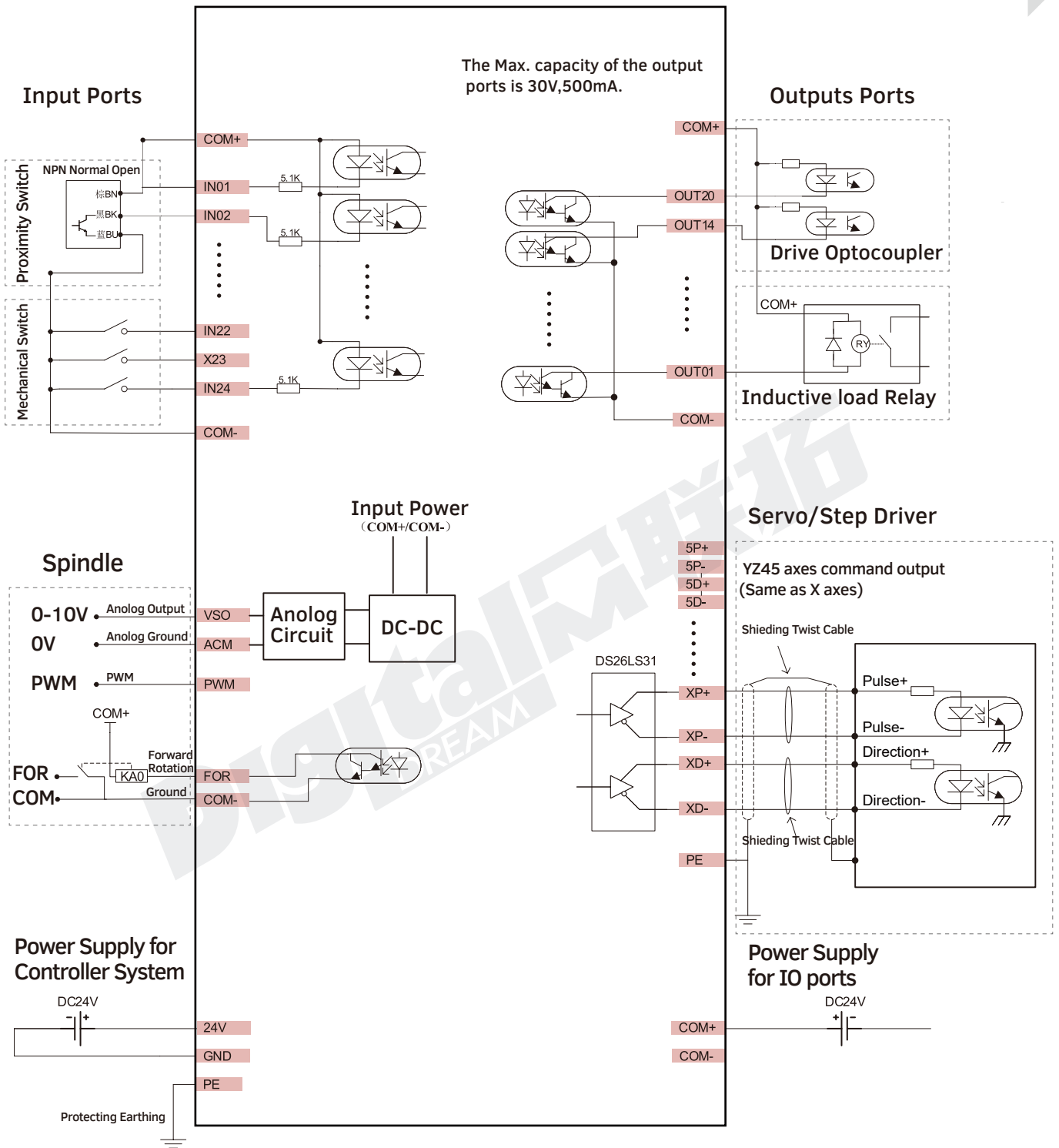

Figure 4-2 Wiring diagram overview

Pin Mark	Name	Function	Parameter
PE	Protecting Earthing	Connect it to the Earth.	
24V	Power Supply Input for Controller System	Positive Side of Power Supply for Controller system	DC24V 3A
GND		Ground	
COM+	Power Supply Input for IO Ports	Positive Side of Power Supply for IO Port	
COM-		Negative side of Power Supply for IO Port	
XP+	X Axis Signal output	Pulse Signal Positive Output of the X Axis (5V)	Cable-driven Output; RS422 Standard; Max. Interpolation Pulse Frequency 1Mhz.
XP-		Pulse Signal Negative Output of the X Axis (5V)	
XD+		Direction Signal Positive Output of the X Axis (5V)	
XD-		Direction Signal Negative Output of the X Axis (5V)	
YD+	Y Axis Signal output	Direction Signal Positive Output of the Y Axis (5V)	
YD-		Direction Signal Negative Output of the Y Axis (5V)	
YP+		Pulse Signal Positive Output of the Y Axis (5V)	
YP-		Pulse Signal Negative Output of the Y Axis (5V)	
ZP+	Z Axis Signal output	Pulse Signal Positive Output of the Z Axis (5V)	
ZP-		Pulse Signal Negative Output of the Z Axis (5V)	
ZD+		Direction Signal Positive Output of the Z Axis (5V)	
ZD-		Direction Signal Negative Output of the Z Axis (5V)	
4P+	4th Axis Signal output	Pulse Signal Positive Output of the 4th Axis (5V)	
4P-		Pulse Signal Negative Output of the 4th Axis (5V)	
4D+		Direction Signal Positive Output of the 4th Axis (5V)	
4D-		Direction Signal Negative Output of the 4th Axis (5V)	
5P+	5th Axis Signal output	Pulse Signal Positive Output of the 5th Axis (5V)	
5P-		Pulse Signal Negative Output of the 5th Axis (5V)	
5D+		Direction Signal Positive Output of the 5th Axis (5V)	
5D-		Direction Signal Negative Output of the 5th Axis (5V)	
FOR	Spindle Start/Stop	Forward Rotation and Stop Output of spindle(OUT21)	The Max. capacity of the output ports is 30V,500mA.
COM-	Spindle Output COMMON	Cannot short connect with ACM	
VSO	Analog Output	Connect with Anaog input port of the inverter	0-10V spindle control
ACM	Analog Ground		
PWM	PWM Output	Connect with PEM input port of the inverter	Duty ratio
ACM	PWM Ground		
IN01 ... IN24	24 Input Ports	In the IO page,can configure the ports as Servo Alarm ,limited,Zero,Probe,Start/Pause/Stop and so on.	Support Mechanical,photoelectric and promixity switch,24VDC; Type: NPN Active Level:0V
OUT01 ... OUT20	20 Output Ports	In the IO page,can configure the ports as Lubrication,Cooling and so on.	Open collector output; Build-in Backward Diode;Driven current: 500mA; Driver voltage: 30V.

4.2 Power Supply Input

DDCS-Expert needs two power supplies, Main power is for controller system, IO Port power is for Input and Output and MPG ports. Both power supply is 24VDC, current is 3A. In the System Power input port, the marked 24V and GND is the main power input ports; In the IO power input ports, the COM+ and COM- is the power input ports for Input/Output Port and MPG. Please keep in mind, only when the two power supplies are connected correctly the controller can be work properly.

Many new users only give system power, then the limited switches, the relay, and MPG and spindle don't work at all, then please go to check if you also give power to IO ports.

IO power gives the power to all the IO ports, include the Limited switch, Relay, MPG, Etop and all other Input and output Ports, without it, spindle, MPG, Input and Output ports cannot work.

In order to avoid electrical noise it is highly recommended to use two separate 24V power supplies.

In order to avoid high-frequency electrical noise from power supply cable, it is highly recommended to install a noise filter at the power input to the switch power supply.

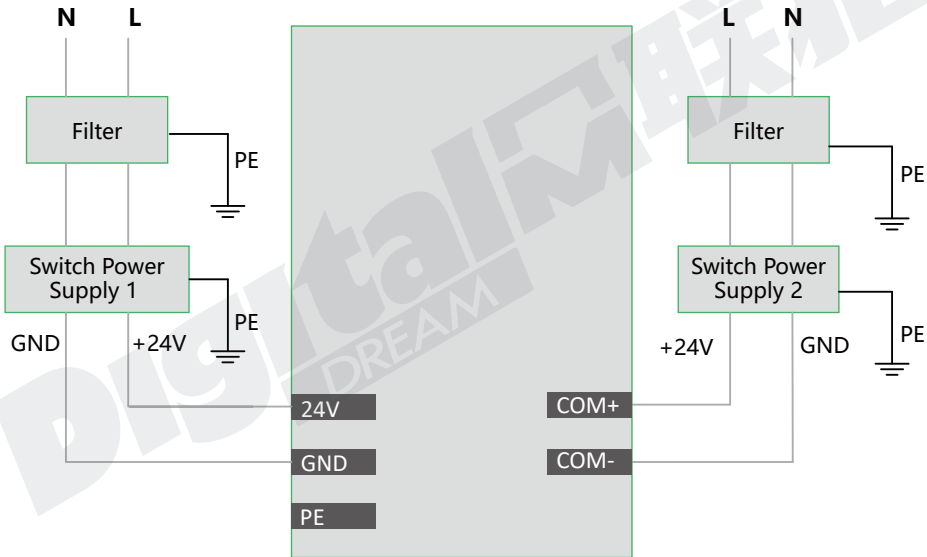

Figure 4-3 Power Supply Wiring Methods

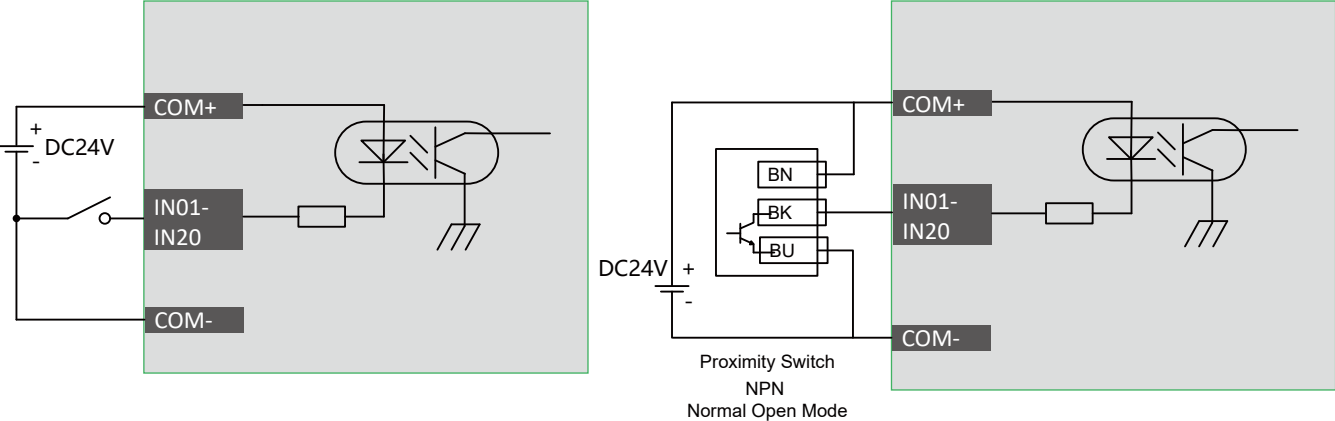

Figure 4-4 How the IO Power gives power to the Input Ports

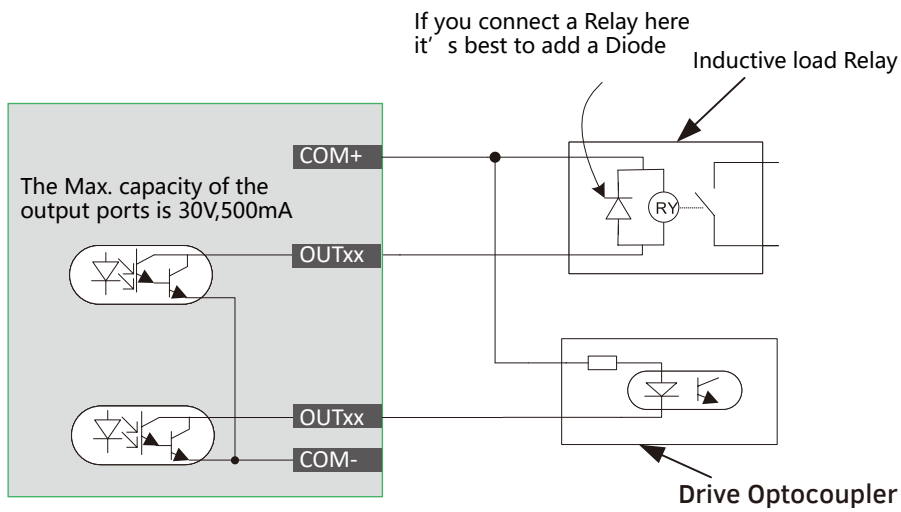

Figure 4-5 How the IO Power gives power to the Output Ports

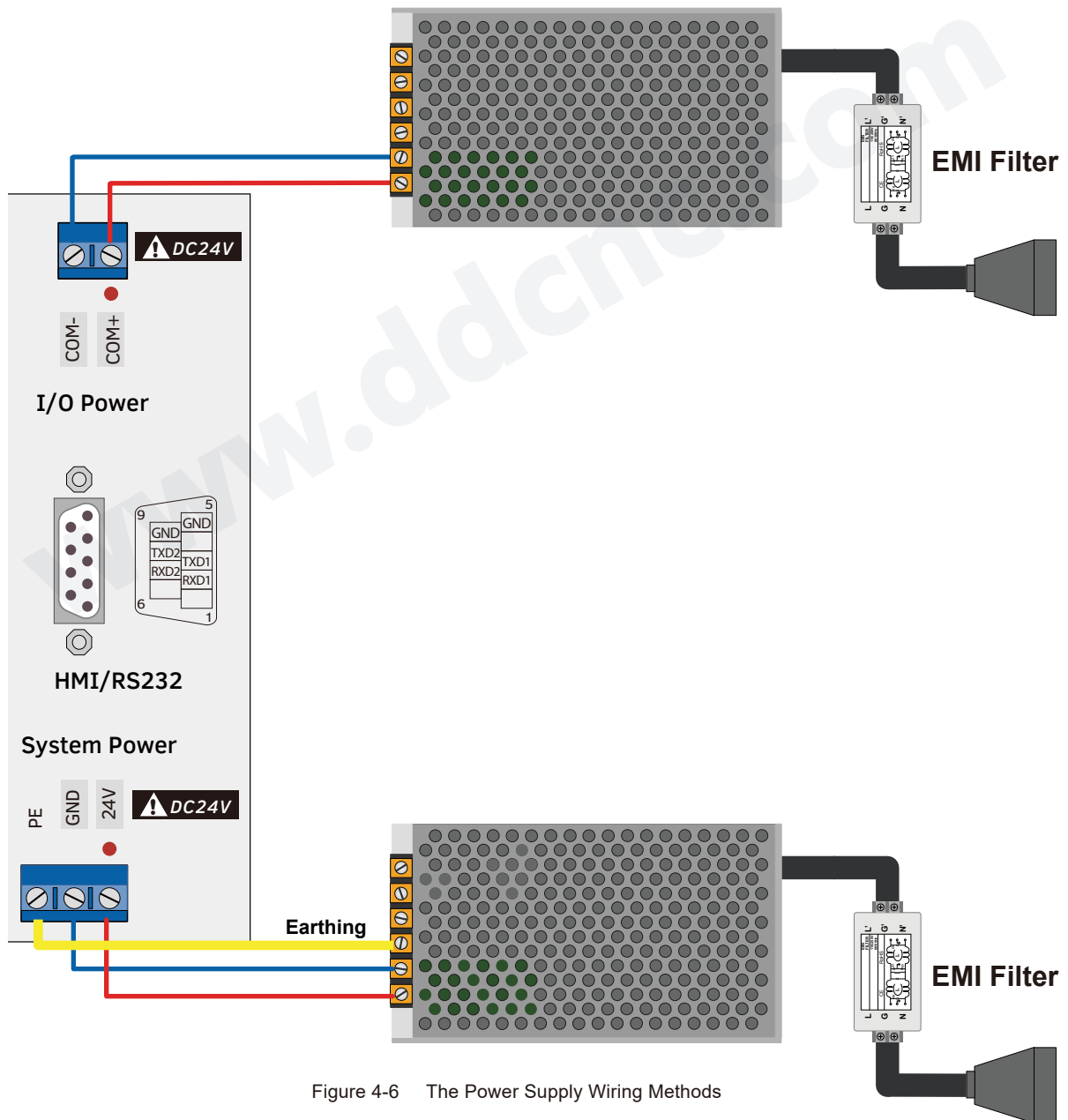

Figure 4-6 The Power Supply Wiring Methods

4.3 Spindle Wiring

DDCS-Expert Support 3 kinds Spindle Mode: Analog Spindle / Servo Spindle (PUL+DIR) / Multi-Speed Spindle. In the Param Page, by #079, we can define the spindle mode.

4.3.1 Analog Spindle

In Analog Spindle, the speed controlling output terminal can output 0-10V. It can adjust the speed of the spindle motor by sending the voltage between 0 and 10V to the VFD according to the Spindle Speed Setting.

Controlling the speed of a spindle with a VFD (variable frequency drive) only needs the Start / Stop signal and the 0-10V signal to control the frequency.

FOR port is same wiring methods as the normal Output Ports.

FOR is for spindle forward rotation output or start / stop output;

Analog circuit is isolated with Power supply output, Never short connect the ACM and COM- (DCM);

If only need the Start and Stop command for the spindle, then just connect FOR output port of the controller with Start input port of the inverter.

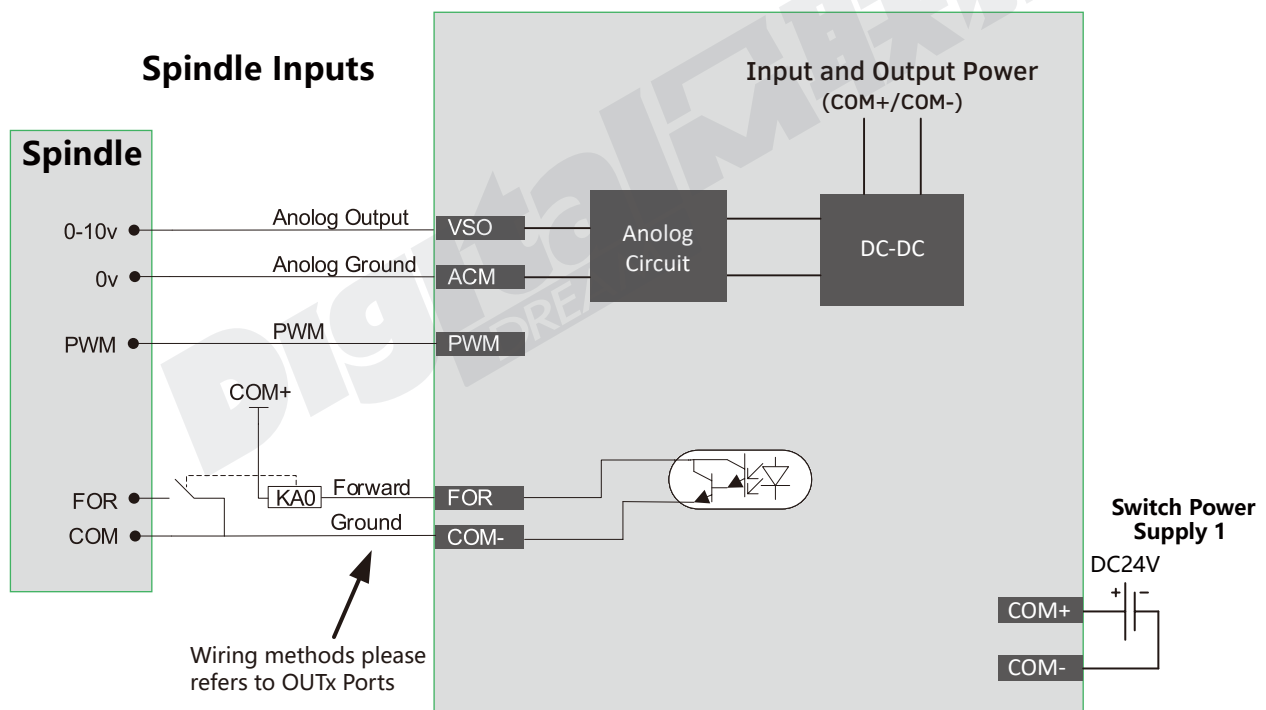

Figure 4-7 Spindle Wiring Methods

Important:

The “VSO” and “PWM” only one port is available for one configuration. Use “VSO” port or “PWM” port, the two ports cannot be used at the same time.

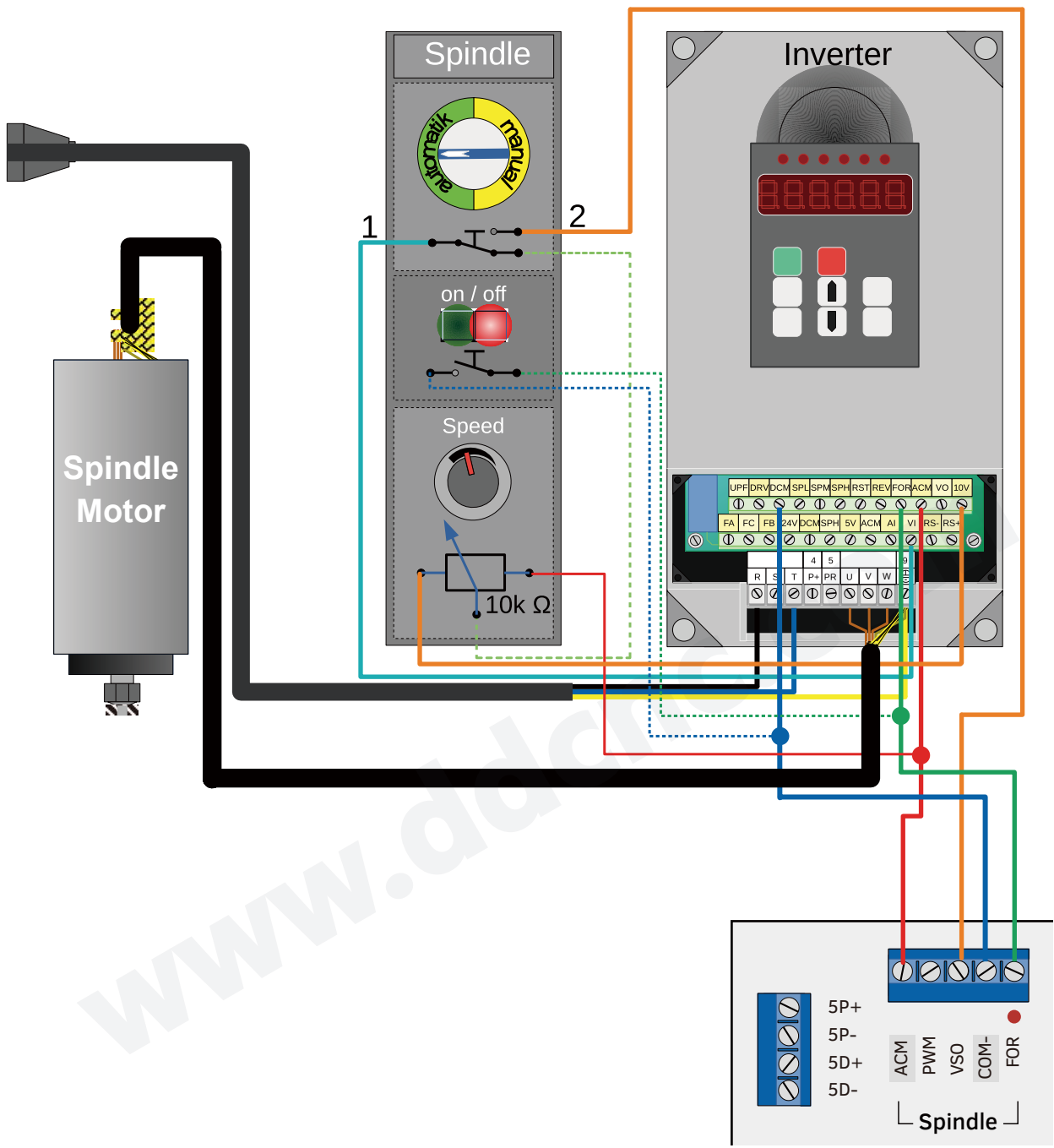

Figure 4-8 Spindle Wiring Example

4.3.2 Servo Spindle (PLUSE/DIRECTION)

In Param Page #079, we set the “ Spindle interface type ” to “ Plu/dir ”, and In Param Page #080 define “ Spindle mapping axis ” to the axis as you need, this axis is defined to be a servo spindle.

4.3.3 Multi-Speed Spindle

There are 3 parameters related to the Multi-speed spindle:

#079 -- “ Spindle interface type ” ; Here we need to set it to “ Multi-speed ”;

#088 -- “ Multi-speed section counts ”; The section count value range is 2-8, the users can set 2-8 different spindle speed.

#082 -- “ Max. Spindle Speed ”.

For example, if the #088 set as 8, and the #082 is 24000, then if the current section is 2, the current spindle speed is 6000; if the current section is 3, the current spindle speed is 9000; if the current section is 4, the current spindle speed is 12000, ect...

There are 3 Output ports related to the Multi-speed spindle, the users need to define them to the according output ports.

Spindle section speed 1 = S1 ;

Spindle section speed 2 = S2 ;

Spindle section speed 3 = S3 ;

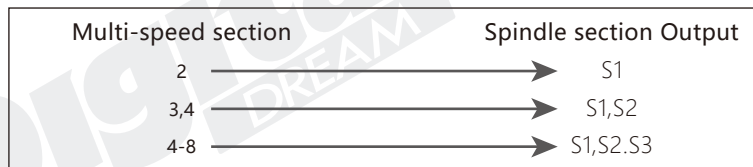

Figure 4-9 The relationship between the Multi-speed section and Spindle section output

Current Section	Output Status		
	S3	S2	S1
1	0	0	0
2	0	0	1
3	0	1	0
4	0	1	1
5	1	0	0
6	1	0	1
7	1	1	0
8	1	1	1

Note: 1 is output, 0 is no output.

Figure 4-10 The Relationship between the Current Section and Output Status

In the IO port Page, we already define the Out20 as “ Spindle section speed 1 ”,Out 19 as “ Spindle section speed 2 ”,Out18 as “ Spindle section speed 3 ”.The the wiring for the Multi-Speed Spindle as follwoing:

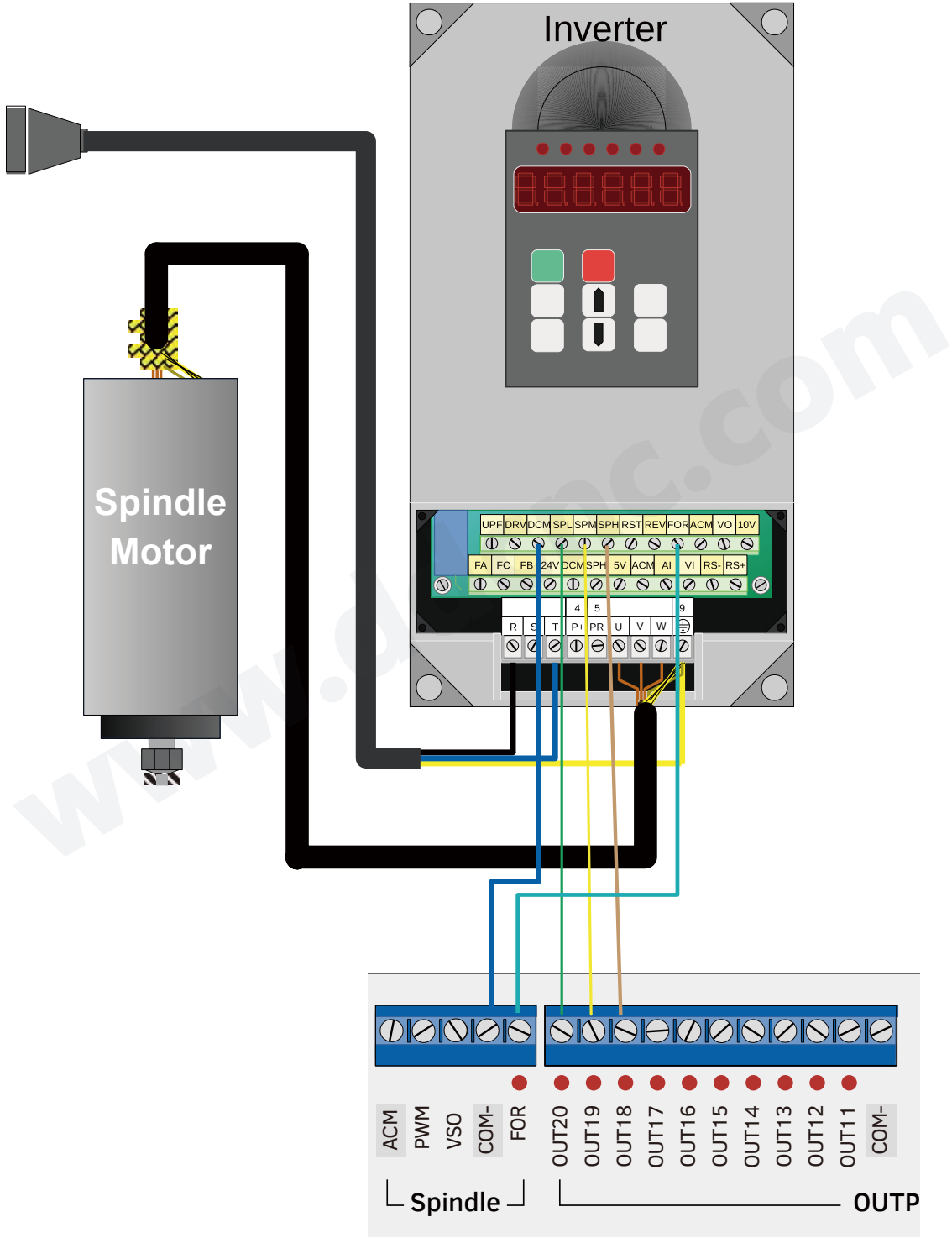

Figure 4-11 The Wiring for the Multi-Speed Spindle

4.3.4 Relay Wiring

By Configuration of more Spindle Output ports, the spindle control output terminal offers connections for Start / Stop of Cooling (M8 / M9) and Start / Stop of Lubrication (M10 / M11) and so on.

For example, it can be used for a Relay output port. Figure 4-12 shows the wiring methods.

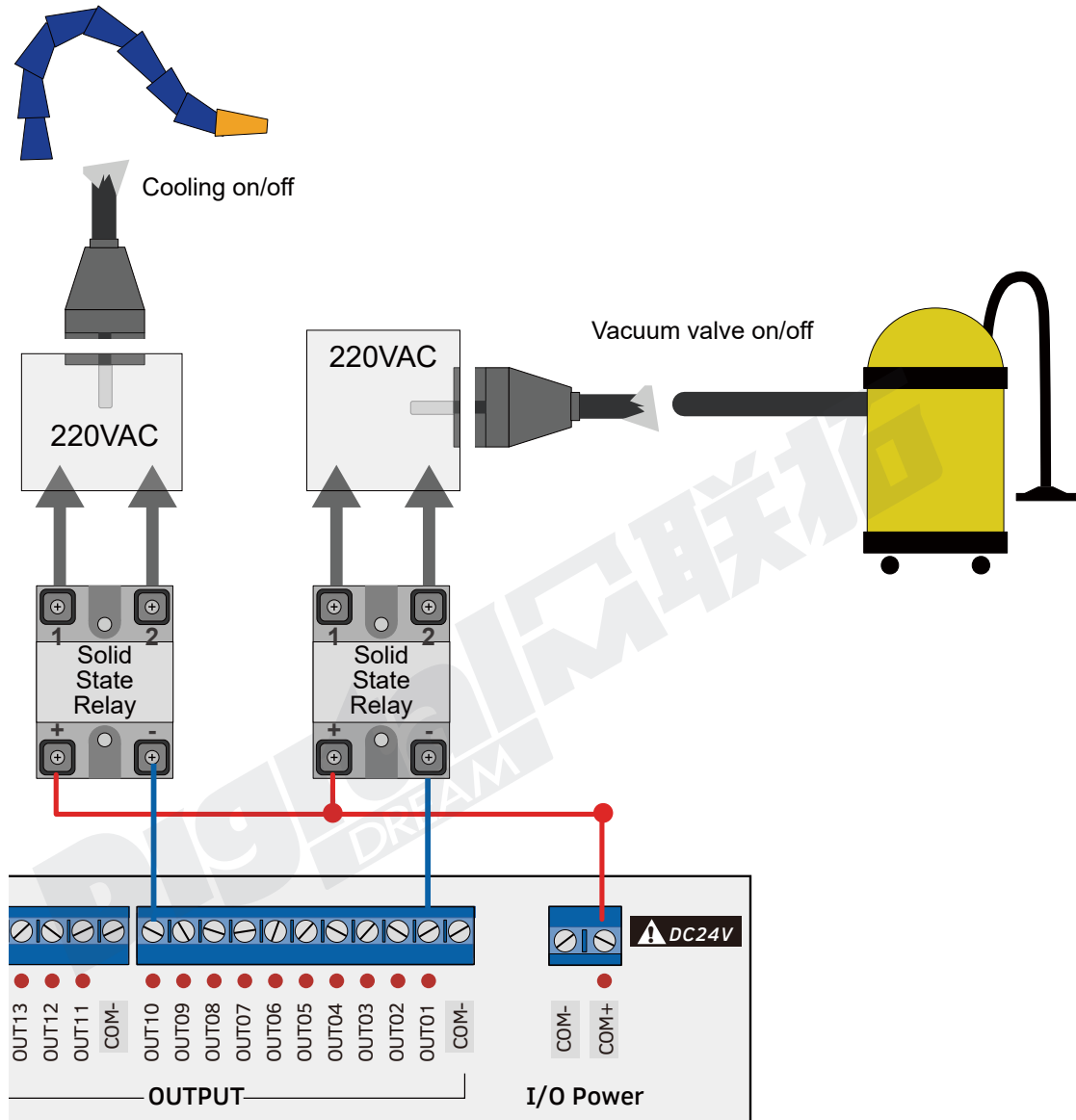

Figure 4-12 The Relay Wiring

If Relay Power Supply is 24VDC:

DDCS Expert Input and Output are the user-defined IO ports,as our example here,we already set OUT10 as the “Cooling on/off” output port,and we already set the OUT01 as Vacuum valve on/off” output port.

If Relay Power Supply is not 24VDC:

The users need to use an external power supply,then please contact us to get the Schematics drawing.

4.4 Stepper /Servo Driver Wiring

The stepper / servo control output, we cite differential Pulse and Direction output method as Figure 4-13, Max. 1Mhz per axis. There is 3 or 4 or 5 axis for optional.

The Figure 4-13 we took X axis as the example, the Y, Z, A, B as the same wiring methods.

The Pulse and Direction signal output voltage is $\pm 5V$.

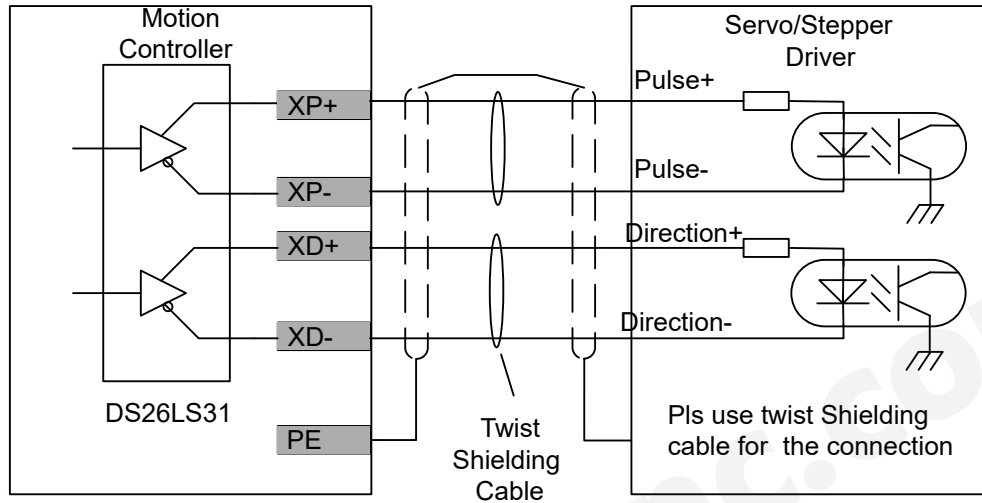

Figure 4-13 Pulse and direction signal wiring methods

Common anode wiring or common cathode wiring, is not DDCS-EXPERT wiring methods. The Figure 4-14 is the wrong wiring method.

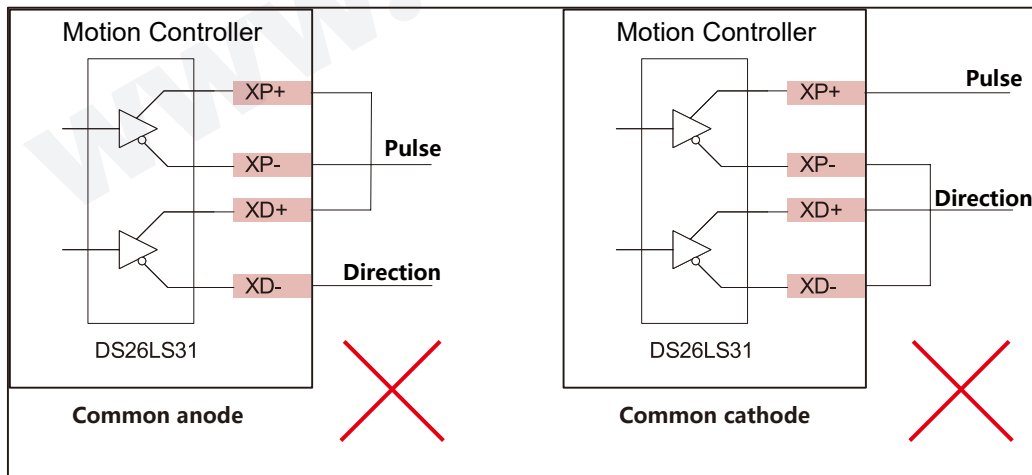

Figure 4-14 Wrong wiring of pulse and direction

DDCSE Input and Output are the user-defined IO ports, In our example, we already set IN24 as the “5th axis servo alarm signal” input port.

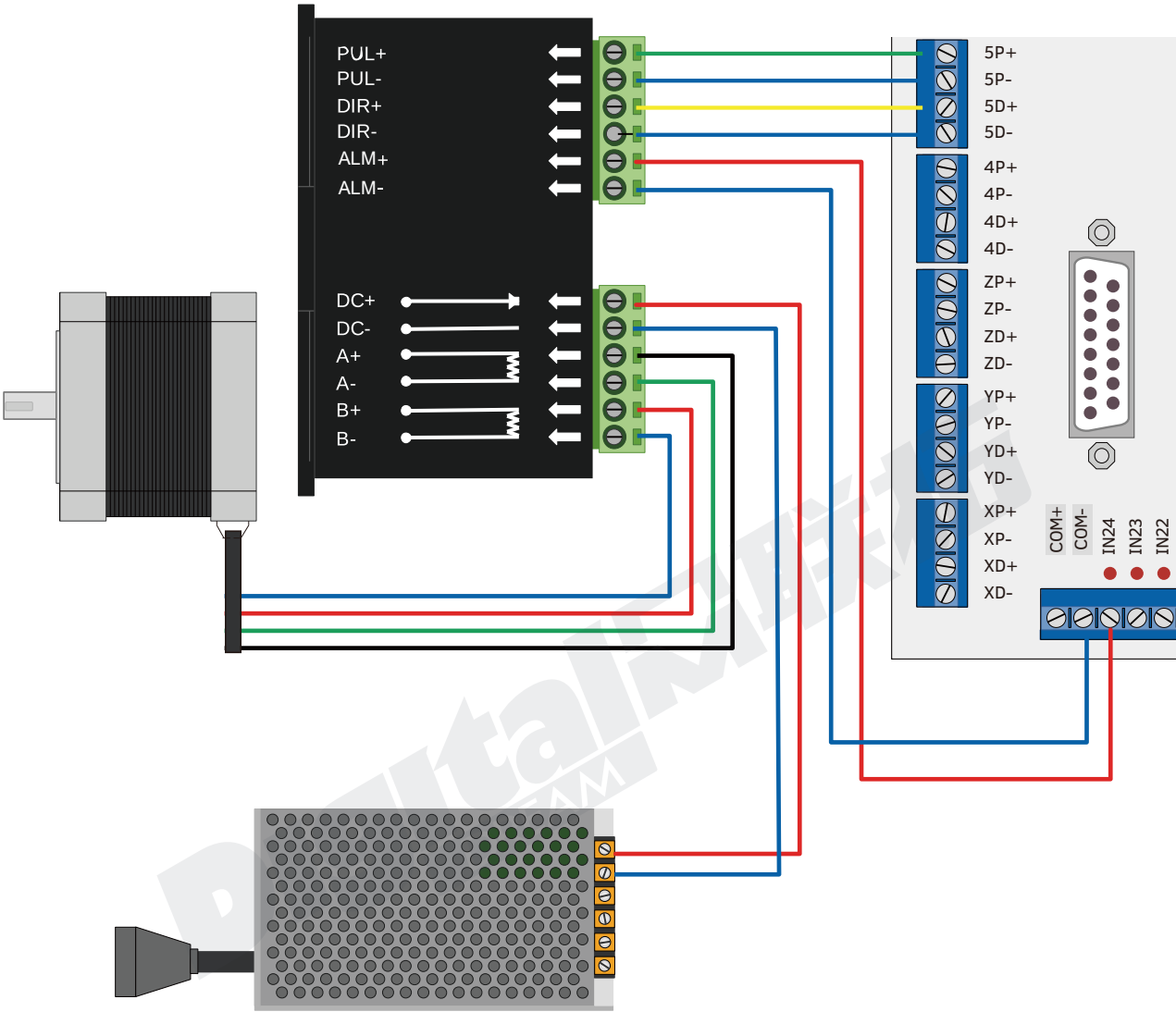

Figure 4-15 Stepper/Servo driver connect with DDCS Expert

4.5 Limit, Home and Probe Inputs

DDCSE Input and Output are the user-defined IO ports, In our example, we already set IN12, IN11 and IN10 as the “ axis limit signal ” Input port, and we already set the IN09 as “ Probe ” output port.

Please note that the limit switch type should be NPN Normal Open, and the voltage range is 24VDC.

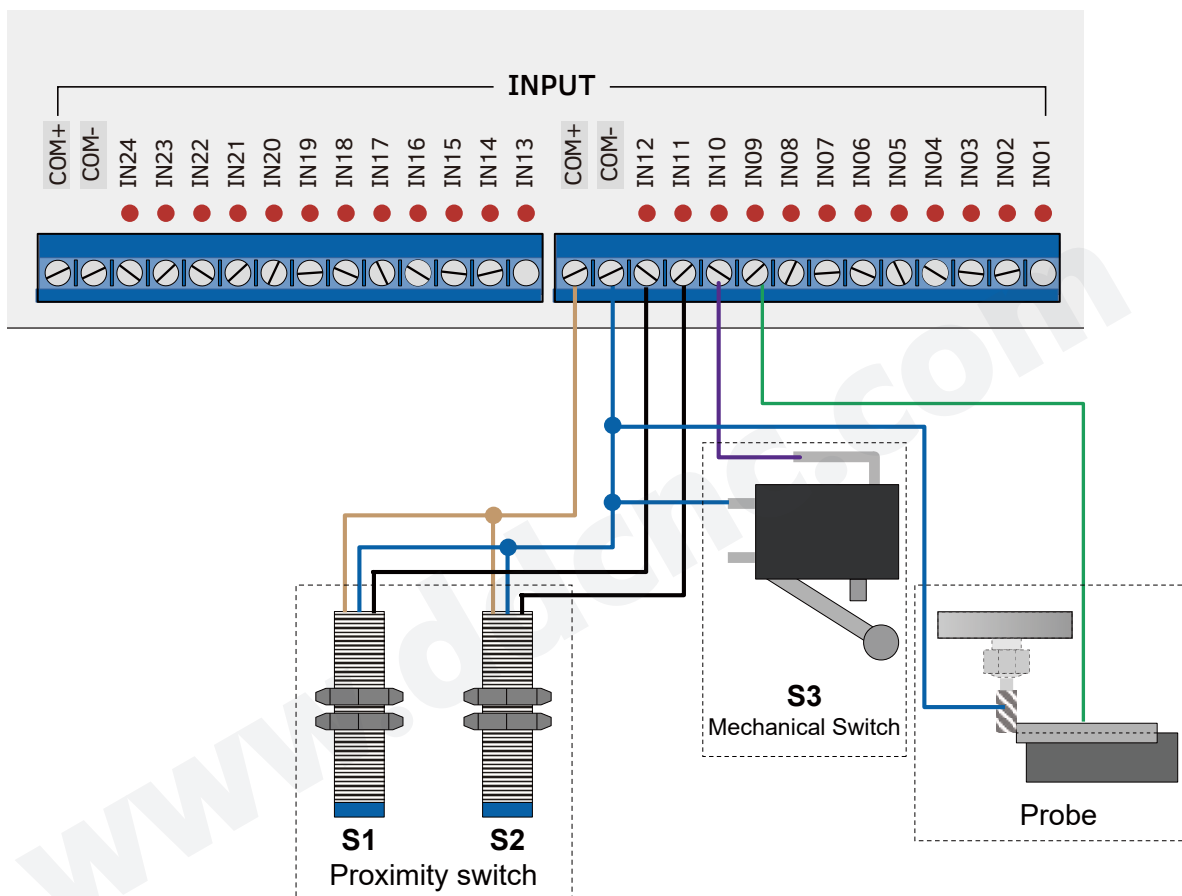

Figure 4-16 Proximity switch/Mecahnical switch and normal Probe wiring methods

Some users asked for the wiring methods for the probe with over-strock alarm, here we also set one sample for it.

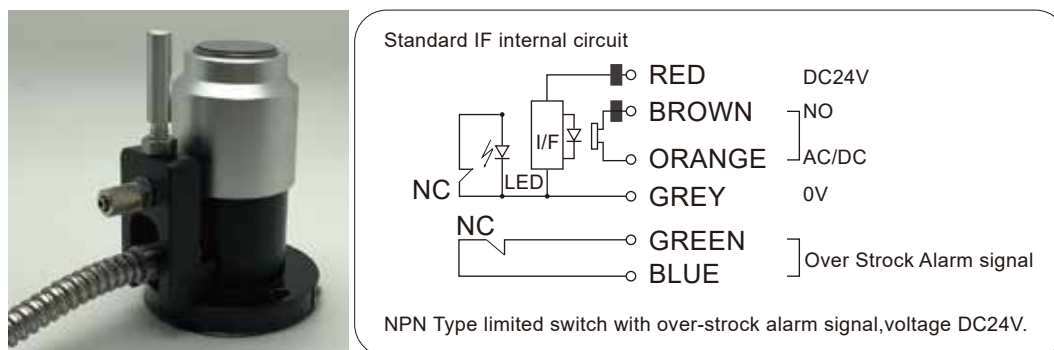

Figure 4-17 The Probe sensor with over-strock alarm signal

In the example, we go to the IO port to sent the IN07 as the “Probe signal”, IN06 as “Negative Z- axis hard limit signal”:

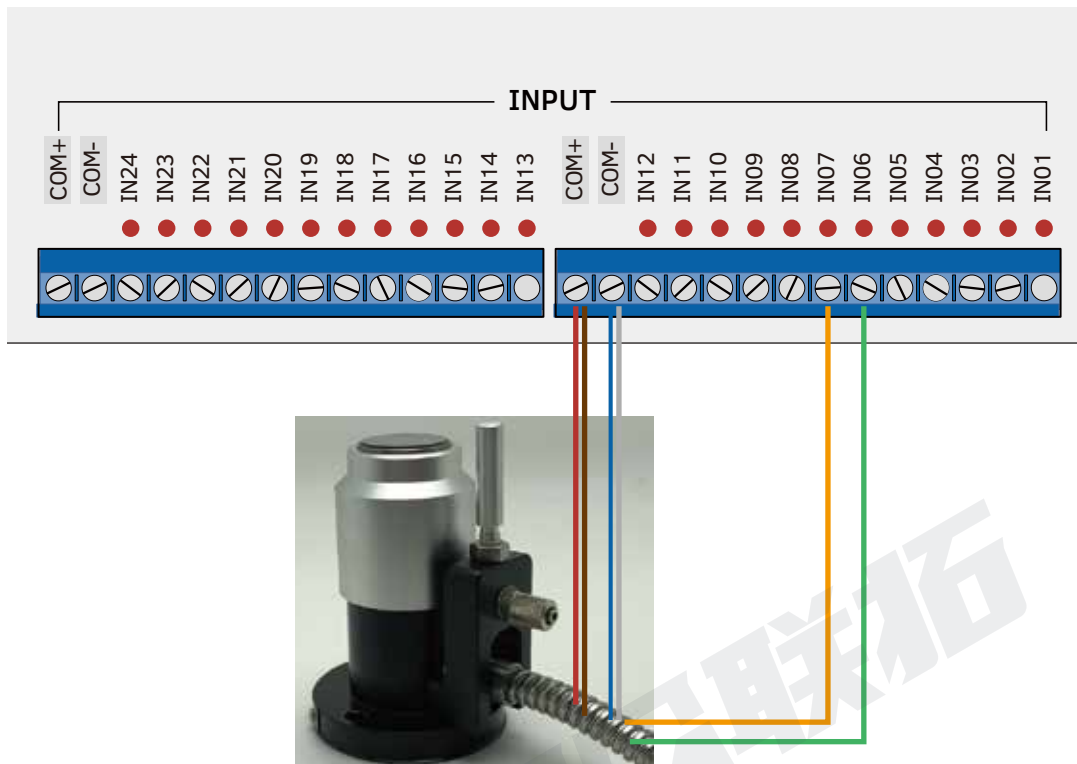

Figure 4-18 The wiring methods of Probe sensor with over-stroked signal

4.6 External Buttons

DDCSE Input and Output are the user-defined IO ports, In our example, we already set IN23 as the “ External Start ” input port, IN22 as the “ External Pause ” input port, and IN21 as “ External Stop ” input Port.

Please choose the external buttons which is 24VDC Power supply input. Then no need an external power supply for them

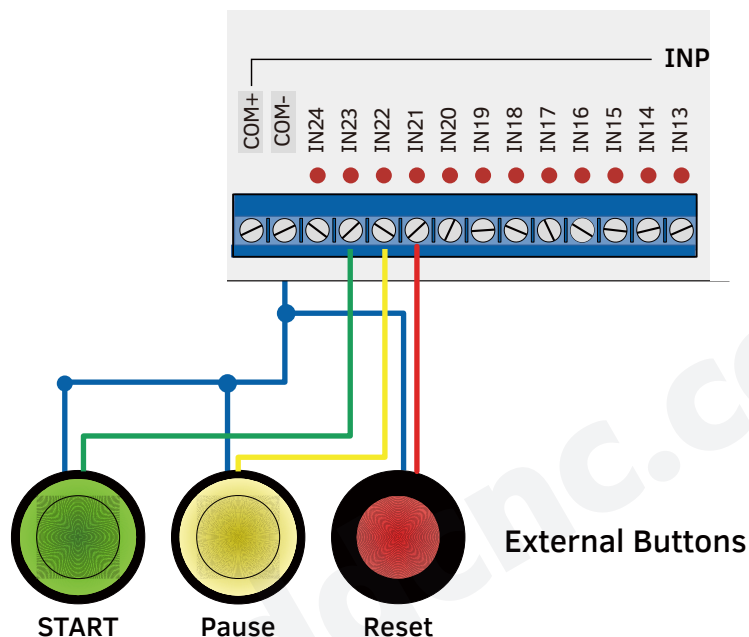
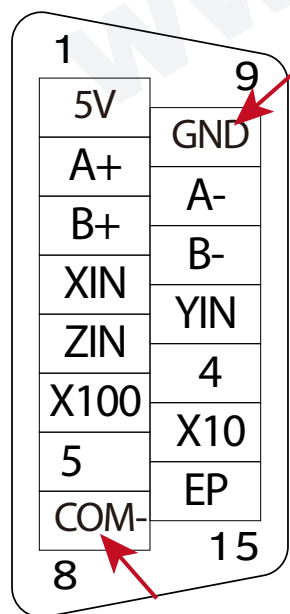

Figure 4-19 The wiring methods of External buttons

4.7 MPG Wiring



Pin No.	Mark	Definition	Notes
1	+5V	Power Supply +	MPG Power supply input positive terminal
2	A+	Encoder A Phase +	MPG A phase differential input positive terminal
3	B+	Encoder B Phase +	MPG B differential input positive terminal
4	XIN	Select X Axis	Connect with GND,then X axis is selected
5	ZIN	Select Z Axis	Connect with GND,then Z axis is selected
6	X100	X100 Ratio	Connect with GND, then X100 ratio is selected
7	5	Select 5th Axis	Connect with GND,then 5th axis is selected
8	COM-	Input signal COMMON	The switch signal common terminal.
9	GND	Ground	MPG power supply ground
10	A-	Encoder A Phase -	MPG A phase differential input negative terminal
11	B-	Encoder B Phase -	MPG B differential input negative terminal
12	YIN	Select Y Axis	Connect with GND,then Y axis is selected
13	4	Select 4th Axis	Connect with GND,then the 4th axis is selected
14	X10	X10 Ratio	Connect with GND, then X10 ratio is selected
15	EP	ESTOP Input	Connect with GND,then Estop is active

*** Never short connect the COM- and GND *** Figure 4-20 MPG wiring table

IMPORTANT:

- 1) All the input signal COMMON terminal is COM-, not GND; **Never short connect GND and COM-**;
- 2) The MPG need the power from IO power port (COM+ / COM-), or the MPG cannot work;
- 3) Because of the limit of the pins, if X10 and X100 is not selected, the system just select X1 by default.
- 4) With the MPG, and press the “Try Cut” key, the system can change to “Handwheel guiding” mode. Please Turn the Handwheel to counterclockwise direction, the Try Cut (Handwheel guiding) can be active.



DDCS-Expert Pin and Mark		MPG Function	MPG Pin and Mark	MPG Output Cable Color
1	+5V	Power Supply +	5V	RED
2	A+	A Phase +	A+	GREEN
3	B+	B Phase +	B+	PURPLE
4	XIN	X Axis	X	YELLOW
5	ZIN	Z Axis	Z	BROWN
6	X100	X100 Ratio	X100	ORANGE
7	5	5th Axis	5	PINK
8	COM-	MPG common COM-	COM	ORANGE/BLACK
9	GND	Ground	GND	BLACK
10	A-	B Phase -	B-	PURPLE/BLACK
11	B-	A Phase -	A-	WHITE
12	YIN	Y Axis	Y	YELLOW/BLACK
13	4	4th Axis	A	BROWN/BLACK
14	X10	X10 Ratio	X10	GREY/BLACK
15	EP	ESTOP	EP	BLUE

Figure 4-21 DDCS - Expert Wiring with DDMPG

In order to make the convenient for the users, we already solder the MPG cables to the PIN15 male interface plug, the users can just insert the MPG plug into the DDCS-Expert MPG interface.

After finished the wiring, we can check the MPG wiring is correct or not in the IO Page.

Look the figure 4-22 and 4-23, X100 and X block turns to red color, that means the X axis and X100 ratio is selected; -499 means the wheels was turned to counterclockwise direction; 922 means the wheels was turned to clockwise direction; -499 or 922 is not the actual distance, they are a measure of the turning speed . + or - shows the direction. So by this way, it is so easy to check the wiring of the MPG.

MPG	BUSY	/udisk-sda1/test.nc								IO	2020/01/29 00:00:08	Guest	
Stat	Port Name								Enable	Pin No.	Polarity		
●	X-axis servo alarm signal								x	NULL	N		
●	Y-axis servo alarm signal								x	NULL	N		
●	Z-axis servo alarm signal								x	NULL	N		
●	Spindle alarm signal								x	NULL	N		
●	5th-axis servo alarm signal								x	NULL	N		
●	negative X-axis hard limit signal								x	NULL	N		
●	negative Y-axis hard limit signal								x	NULL	N		
●	negative Z-axis hard limit signal								x	NULL	N		
●	negative 4th-axis hard limit signal								x	NULL	N		
●	negative 5th-axis hard limit signal								x	NULL	N		
●	positive X-axis hard limit signal								x	NULL	N		
●	positive Y-axis hard limit signal								x	NULL	N		
IN	IN01	IN02	IN03	IN04	IN05	IN06	IN07	IN08	IN09	IN10	IN11	IN12	IN13
	IN14	IN15	IN16	IN17	IN18	IN19	IN20	IN21	IN22	IN23	IN24		
MPG	X1	X10	X100	HX	HY	HZ	HA	HB		-449		0	
OUT	OUT01	OUT02	OUT03	OUT04	OUT05	OUT06	OUT07	OUT08	OUT09	OUT10	OUT11	OUT12	OUT13
	OUT14	OUT15	OUT16	OUT17	OUT18	OUT19	OUT20	OUT21					
▲	Out Open		Out Close					Change Polarity					

Figure 4-22 Turning wheels in CCW direction

MPG	BUSY	/udisk-sda1/test.nc								IO	2020/01/29 00:01:28	Guest	
Stat	Port Name								Enable	Pin No.	Polarity		
●	X-axis servo alarm signal								x	NULL	N		
●	Y-axis servo alarm signal								x	NULL	N		
●	Z-axis servo alarm signal								x	NULL	N		
●	Spindle alarm signal								x	NULL	N		
●	5th-axis servo alarm signal								x	NULL	N		
●	negative X-axis hard limit signal								x	NULL	N		
●	negative Y-axis hard limit signal								x	NULL	N		
●	negative Z-axis hard limit signal								x	NULL	N		
●	negative 4th-axis hard limit signal								x	NULL	N		
●	negative 5th-axis hard limit signal								x	NULL	N		
●	positive X-axis hard limit signal								x	NULL	N		
●	positive Y-axis hard limit signal								x	NULL	N		
IN	IN01	IN02	IN03	IN04	IN05	IN06	IN07	IN08	IN09	IN10	IN11	IN12	IN13
	IN14	IN15	IN16	IN17	IN18	IN19	IN20	IN21	IN22	IN23	IN24		
MPG	X1	X10	X100	HX	HY	HZ	HA	HB		922		0	
OUT	OUT01	OUT02	OUT03	OUT04	OUT05	OUT06	OUT07	OUT08	OUT09	OUT10	OUT11	OUT12	OUT13
	OUT14	OUT15	OUT16	OUT17	OUT18	OUT19	OUT20	OUT21					
▲	Out Open		Out Close					Change Polarity					

Figure 4-23 Turning wheels in CW direction

And in the Main Page, no matter the controller is in MPG or CONT or Step mode, just switch the MPG from Off to ON, the controller mode just turns to MPG mode;and also easily to see which axis the MPG is in, there will be a little mark on the related axis.



Figure 4-24 The MPG channel is on X axis

Note: If you want to use the single-terminal MPG (there is no A-B-MPG), please refer to Figure 4-25 for reference. As for the unlisted MPG, please take the differential MPG wiring mode.

DDCS Wiring Pin Mark	MPG Pin Mark and Color	
A+	A+	Green
A-	0V	Black
B+	B+	White
B-	0V	Black

Figure 4-25 DDCS Expert Wiring with Single-terminal MPG

4.7 Series Port Wiring

Series Port is for Modbus extension, it helps to extend with IO card, or the communication with PLC. If some users need it please contact factory and we will guide you for it.

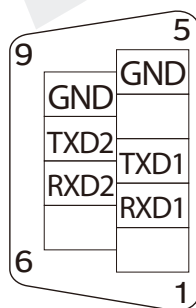

Pin No.	Mark	Definition	Notes
1			
2	RXD1	Serial port 1 Receiver	
3	TXD1	Serial port 1 Sender	
4			
5	GND1	Serial port 1 Ground	
6			
7	RXD2	Serial port 2 Receiver	Serial port level is 232
8	TXD2	Serial port 2 Sender	Serial port level is 232
9	GND2	Serial port 2 Ground	

Figure 4-26 Series Ports wiring

5 Software and Monitor

Software Structure Part 1

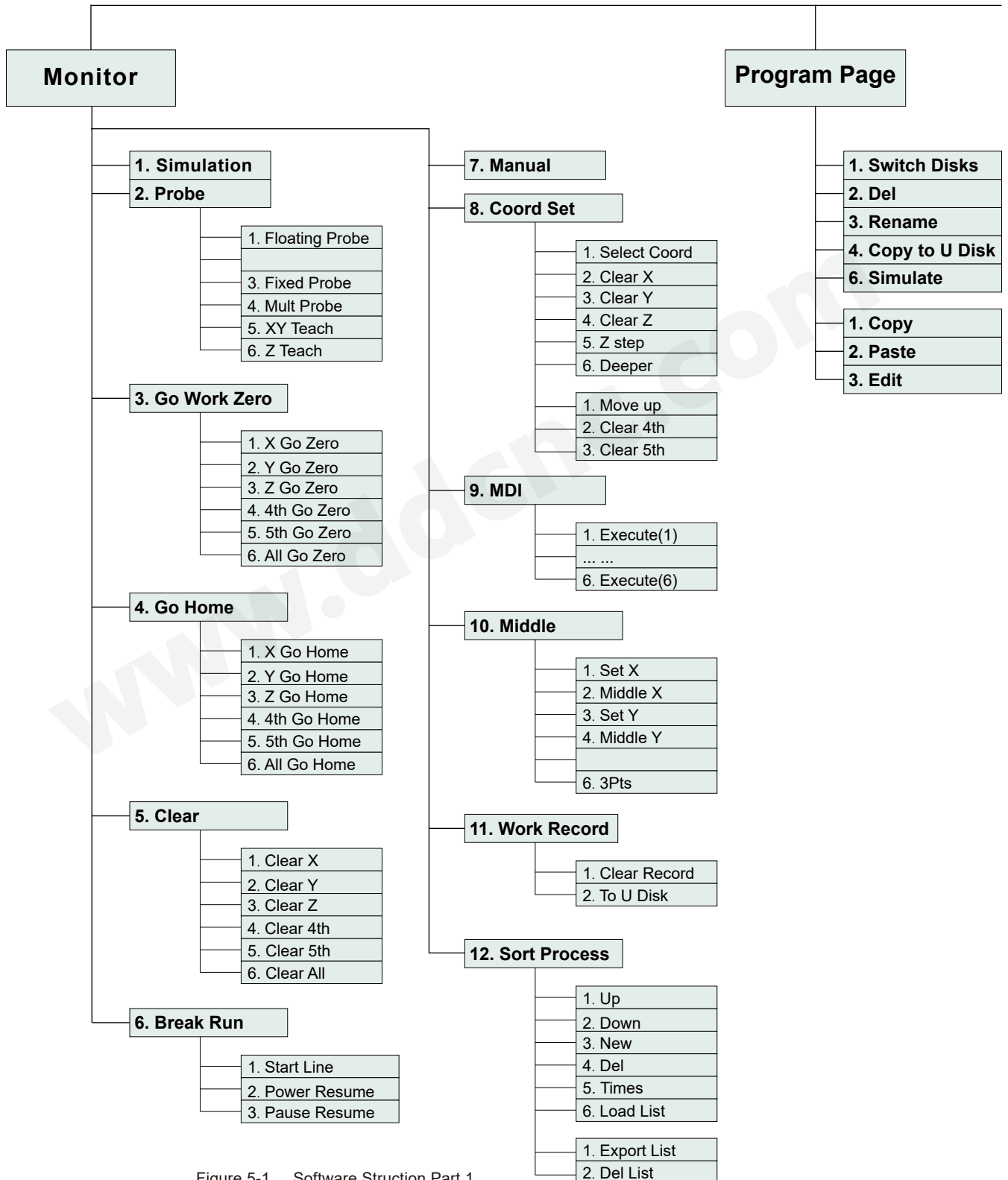

Figure 5-1 Software Struction Part 1

Software Structure Part 2

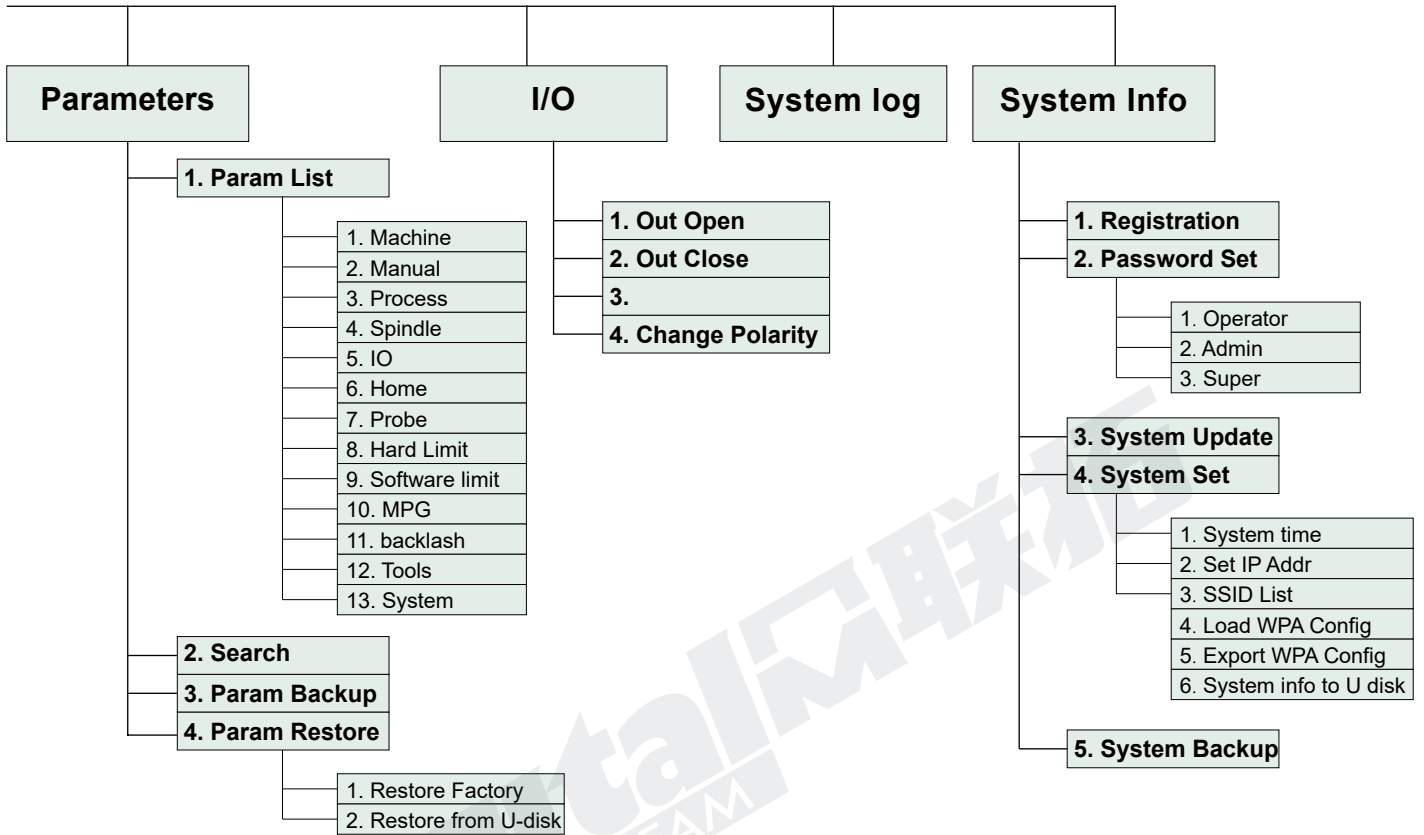

Figure 5-2 Software Struction Part 2

5.1 The Main Page of the software

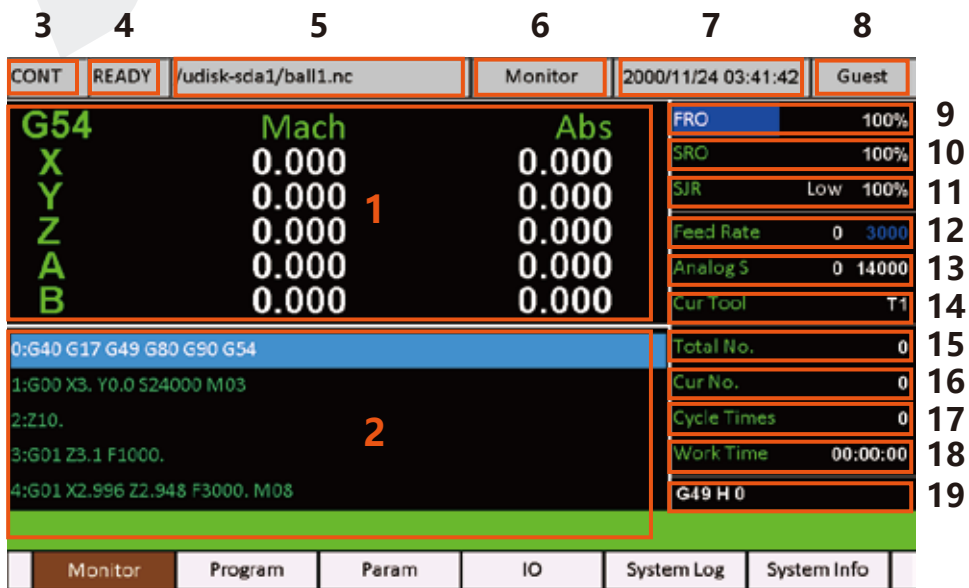

Figure 5-3 Main Page of Monitor

The Figure 5-3 shows the Main Page of the DDCS Expert. It is divided into status column, coordinate display column, basic parameter column, and notification column. In total, it is divided into 19 sections in detail. Here the detailed description of the 19 sections :

1、XYZAB Coordinate

This column shows the Machine coordinate and Current coordinate value of XYZAB axis. The display range is -99999.999 ~ +99999.999 in mm;

2、Status

When the controller runs the G code file, it will show the current operation line and operation status.

3、Feed status

This window shows the feed status of CONT.

AUTO: displayed while processing and executing the G code file

CONT: indicates Jog CONTINUOUS. You can Jog manually with the “-” or “+” keys of X Y Z and A and B.

STEP: Indicates STEP Jog mode. You can Jog manually in a defined distance with the “-” or “+” keys of X Y Z and A and B.

MPG: Only when shift to MPG mode, you can operate MPG on the controller.

4、Operating Status

This column shows the operating state. The status and implications can be displayed as follows:

Busy: Operation is running

Reset: Reset flashing = controller not active. To activate the controller click Reset

READY: Ready state. Controller is ready and all operations can be performed

5、Processing file

This column shows the name of the processing file and file path.

6、Software Interface

This column shows the current software interface.

7、Date and working time

This column shows the date and working time. The Date can be reset.

8、 User ' s rights

This controller Support 4 kinds operation rights: visitor, operator, admin, super admin.T his column shows the current rights.

9、 FRO

FRO controls the Feed Speed. Click FRO till FRO is highlighted. Use rotary button (knob) or Up / Down keys to adjust the Feed Speed in 1% increments, the range is 0% - 120%.

10、 SRO

SRO controls the Spindle Speed. Click FRO till SRO is highlighted, use rotary button(knob) or Up / Down keys adjust the Spindle Speed in 1% increments, the range is 0% - 150%.

11、 SJR / Jog Step

Press the  Key, the feed status shift among in CONT, STEP and MPG.

When the controller mode is CONT and MPG, it will show the SJR.

SJR controls the jogging of the machine. Turnning the rotary button (knob) till SJR is highlighted. Turnning rotary button (knob) or Up / Down keys to adjust the speed in 1% increments. The range is 0% - 120%. Press knob to enter the setting.

When in Step Mode, Pressing the rotary button (knob) or keys to change between the 4 distances 0.001 / 0.01 / 0.1 / 1 or define any distance.

When in MPG mode you can use the MPG to jog the machine

High/Low Speed: Manually speed

12、 Feed speed

F stands for Feed Speed. Turnning the rotary button or clicking up or down keys till F is highlighted, click button or Enter to modify and edit the value you want.

Here you can ignore the F value, then the system will use the F value from Gcode file, and also you can define a default F value. When the color the number is blue, then the system uses the default value, if the color is white, the system uses F speed from G-cdode file.

13、 Speed of spindle

Anolog S stands for Spindle Speed. Turnning the rotary button or clicking up or down keys till Analog S is highlighted, click button or Enter to modify and edit the value you want.

Here you can Ignore the S value, then the system will use the S value from Gcode file, and also you can define a defalt S value.

When the color the number is blue, then the system uses the default value,if the color is white, the system uses S speed from G-cdode file.

14、Cur Tool :

This column display the current Tool No.

15、 Total No.

Total Machinning No.

16、 Cur No.

Current Machinning No.

When the Gcode file changed,t he number will be cleared to 0.

When excute M47 or M30, the counter will add 1, the working time cleared to 0; When M47 reached to the cycle times, the system pauses,and the number cleared to 0.

17、 Cycle Times

Set a limited number of cycle times.

When system excute M47 from cycle Gcode file,and M47 excuting time reaches to cycle times which you set, system just pause itself, and clear current machinning No.

18.Work Time

The working time for the current G-code file.



When restart the program,it will start to count.

19. G49 H 0

The compensation setting.

5.1.1 FRO

FRO: Feed Rate Override.

In the Main Page, By the Rotary button (Knob)  or the  and  keys, we can shift among the different columns. We move the cursor, select FRO and enter, the percent number becomes blue, then we can use the knob or the Up / Down keys to edit the numbers. The percent number increase or decrease in 1%, range is 0% - 120%.

After the setting done, don't forget to press Enter to active the FRO.





FRO	98%
SRO	100%
SJR	Low 100%
Feed Rate	0 3000
Analog S	0 24000
Cur Tool	T1
Total No.	7
Cur No.	0
Cycle Times	0
Work Time	00:00:00

Figure 5-4 When the percent number is Blue,we can edit FRO

5.1.2 SRO

SRO: Spindle Rate Override

In the Main Page, By the Rotary button(Knob)  or the  and  keys, we can shift among the different columns. We move the cursor, select SRO and enter, the percent number becomes blue, then we can use the knob or the Up/Down keys to edit the numbers. The percent number increase or decrease in 1%, range is 0% - 150%.



After the setting done, don't forget to press Enter to active the SRO.

FRO	98%
SRO	133%
Jog step	Low 0.001
Feed Rate	0 3000
Analog S	0 24000
Cur Tool	T1
Total No.	7
Cur No.	0
Cycle Times	0
Work Time	00:00:00
G49 H 0	

Figure 5-5 When the percent number is Blue,we can edit SRO

5.1.3 SJR/Jog Step

When the controller mode is CONT or MPG, it is “ SJR ”; When the controller mode is STEP,it is “ Jog Step ”.

When in the CONT or MPG mode, By the Rotary button(Knob)  or the  and  keys, we can shift among the different columns. We move the cursor, select SJR and enter, the percent number becomes blue, then we can use the knob or the Up / Down keys to edit the numbers. The percent number increase or decrease in 1%,range is 0% - 120%.

After the setting done, don’ t forget to press Enter to active the SJR.

FRO	98%
SRO	137%
SJR	Low 118%
Feed Rate	0 3000
Analog S	0 24000
Cur Tool	T1
Total No.	7
Cur No.	0
Cycle Times	0
Work Time	00:00:00
G49 H 0	

Figure 5-6 When the percent number is Blue,we can edit SJR

Now we Press  key and shift the mode to STEP.

We press Enter and there a pull-down menu pop out. Now We have 5 choice: 0.001mm, 0.01mm, 0.1mm, 1mm and “ INC Distance ”. INC Distance means the users can define the distance at any value. We move the cursor to “ INC Distance ”, Press Enter and input 50, Enter, then a 50mm Step distance is active.



Figure 5-7 In Jog Step Mode



Figure 5-8 Define Distance





Figure 5-9 Input Number



Figure 5-10 new distance active

5.1.4 Feed Rate

In the “ Feed Rate ” column, we can define the default feeding rate, we can define the current working feedrate is F command from G-code or the feedrate value we set.

By the Rotary button(Knob)  or the  and  keys, we can shift among the different columns to “ Feed Rate ”. We press the Enter button, a small window pop up from the bottom. The “ Ignore F Yes ”, means Ignore the F command from the G-code, then the system will process by the F command we set here; The “ Ignore F No ” means the system ignore the Feed rate we set, control system will process by the F command from G-code file.

FRO	100%
SRO	100%
SJR	Low 100%
Feed Rate	0 3000
Analog S	0 24000
Cur Tool	T1
Total No.	0
Cur No.	0
Cycle Times	0
Work Time	00:00:00
G49 H 0	

Figure 5-11 Shift to FeedRate Column

FRO	100%
SRO	100%
SJR	Low 100%
Feed Rate	0 3000
Analog S	0 24000
Cur Tool	T1
Total No.	0
Cur No.	0
Cycle Times	0
Ignore F Yes	
Set default F	

Figure 5-12 Ignore F from G-code file

FRO	100%
SRO	100%
SJR	Low 100%
Feed Rate	0 3000
Analog S	0 24000
Cur Tool	T1
Total No.	0
Cur No.	0
Cycle Times	0
Work Time	00:00:00
G49 H 0	

Figure 5-13 FeedRate value is active

FRO	100%
SRO	100%
SJR	Low 100%
Feed Rate	0 3000
Analog S	0 24000
Cur Tool	T1
Total No.	0
Cur No.	0
Cycle Times	0
Ignore F NO	
Set default F	

Figure 5-14 Ignore FeedRate Value

FRO	100%
SRO	100%
SJR	Low 100%
Feed Rate	0 3000
Analog S	0 24000
Cur Tool	T1
Total No.	0
Cur No.	0
Cycle Times	0
Work Time	00:00:00
G49 H 0	

Figure 5-15 F command from G-code file is active

And we can define the FeedRate Value by the pressing enter on “ Set Default F ”. We can write in numbers and press Enter again. Then the Feedrate value is done.



Figure 5-16 Set the Default Feed Rate



Figure 5-17 Write in the Value



Figure 5-18 The new Feed Rate Value already set

5.1.5 Analog S/Servo S/Multi-Speed

Because DDCS-Expert Controller has three kind Spindle Mode:

- 1) Analog: When the controller control the spindle speed by the analog 0-10V voltage output;
- 2) Plu/Dir: When define the spindle mode as the Servo Spindle;
- 3) Multi-Speed (Multi Spindle Speed): When the controller control the spindle speed by 3 input ports, this is Multi spindle speed control.

Go to the Param Page and find the #79 parameter,press Enter,there are 3 options.Each option decide different spindle Mode:

STEP	READY	/udisk-sca1/test.nc	Param	2020/01/27 06:47:12	Super
Param List:					
	No.	Note	Value		
Machine	0230	Execute action after Finished	No action		
Manual	0282	G00 ACC	2000.000		
----- Spindle -----					
Process	0079	Spindle interface type	Analog		
Spindle	0080	Spindle mapping axis	Analog		
IO	0081	Spindle start delay			
	0082	Maximum spindle speed	Plu/dir		
Home	0083	Ignore the S command			
Probe	0084	Stop spindle when program is paused?	Multi-speed		
	0085	Default spindle speed			
Hard Limit	0088	Multi-speed section counts	3		
Software limit	0089	Spindle stop delay	0.000		
MPG	---	IO	-----		
Backlash	0092	Duration of M8/M9 commands	2.000		
Tools	Range:	[0~2]	Active:	Immediately	User: Operator
System	Details:	Spindle interface type.			
▲	Param List	Search	Param Backup	Param Restore	

Figure 5-19 3 different spindle modes

FRO	100%
SRO	100%
SJR	Low 100%
Feed Rate	0 4000
Analog S	0 24000
Cur Tool	T1
Total No.	0
Cur No.	0
Cycle Times	0
Work Time	00:00:00
G49 H 0	

Figure 5-20 Spindle in Analog Mode

FRO	100%
SRO	100%
SJR	Low 100%
Feed Rate	0 4000
Servo S	0 24000
Cur Tool	T1
Total No.	0
Cur No.	0
Cycle Times	0
Work Time	00:00:00
G49 H 0	

Figure 5-21 Spindle in Pul/Dir Mode

FRO	100%
SRO	100%
SJR	Low 100%
Feed Rate	0 4000
Mult S	0-1 24000
Cur Tool	T1
Total No.	0
Cur No.	0
Cycle Times	0
Work Time	00:00:00
G49 H 0	

Figure 5-22 Spindle in Multi-Speed Mode

Here we only take the example of “Analog S” when the spindle mode is in Analog, to set the example:

By the Rotary button(Knob)  or the  and  keys, we can shift among the different

columns to “Analog S”. We press the Enter button, a small window pop up from the bottom. The “Ignore S Yes”, means Ignore the S command from the G-code, then the system will process by the S command we set here; The “Ignore S No” means the system ignore the Analog Spindle speed we set, control system will process by the S command from G-code file.

FRO	100%
SRO	100%
SJR	Low 100%
Feed Rate	0 3000
Analog S	0 24000
Cur Tool	T1
Total No.	0
Cur No.	0
Cycle Times	0
Work Time	00:00:00
G49 H 0	

Figure 5-23 Shift to Analog S Column

FRO	100%
SRO	100%
SJR	Low 100%
Feed Rate	0 3000
Analog S	0 24000
Cur Tool	T1
Total No.	0
Cur No.	0
Cycle Times	0
Ignore S Yes	
Set default S	

Figure 5-24 Ignore S from G-code file

FRO	100%
SRO	100%
SJR	Low 100%
Feed Rate	0 3000
Analog S	0 24000
Cur Tool	T1
Total No.	0
Cur No.	0
Cycle Times	0
Work Time	00:00:00
G49 H 0	

Figure 5-25 Analog S value is active

FRO	100%
SRO	100%
SJR	Low 100%
Feed Rate	0 3000
Analog S	0 24000
Cur Tool	T1
Total No.	0
Cur No.	0
Cycle Times	0
Ignore S NO	
Set default S	

Figure 5-26 Ignore Analog S Value

FRO	100%
SRO	100%
SJR	Low 100%
Feed Rate	0 3000
Analog S	0 24000
Cur Tool	T1
Total No.	0
Cur No.	0
Cycle Times	0
Work Time	00:00:00
G49 H 0	

Figure 5-27 S command from G-code file is active

And we can define the Analog Spindle Speed Value by the pressing enter on “ Set Default S ”. We can write in numbers and press Enter again. Then the Analog Spindle Speed setting is done.

When the spindle mode is in other two kinds mode,the operation is the same.



Figure 5-28 Set the Default Spindle Speed

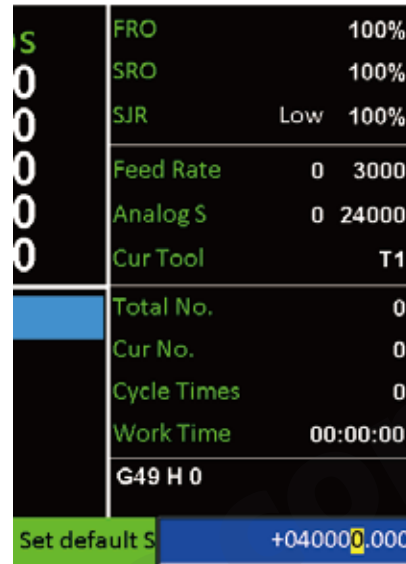

Figure 5-29 Write in the Value



Figure 5-30 The new Spindle speed setting is done

5.2 Simulation

There are many Parameters related to the Simulation function:

Param #	Definition	Remark	Range
#244	Enable realtime toolpath	When processing a file,active realtime toolpath or not	Yes/No
#245	Toolpath mode	The Toolpath display modes	Statue/Line/3D
#261	X-axis rotation angle in 3D toolpath mode	Can set a angle to simulate Based on X axis	-180~180
#262	Y-axis rotation angle in 3D toolpath mode	Can set a angle to simulate Based on Y axis	-180~180
#263	Z-axis rotation angle in 3D toolpath mode	Can set a angle to simulate Based on Z axis	-180~180

In order to make the Simulation function active, we must set #244 to “Yes”;

And if the setting of #245 is “Line”, the system response can be quicker than Statue and 3D.

In the Monitor Page and Press F1, go to First Sub-Page of Monitor :

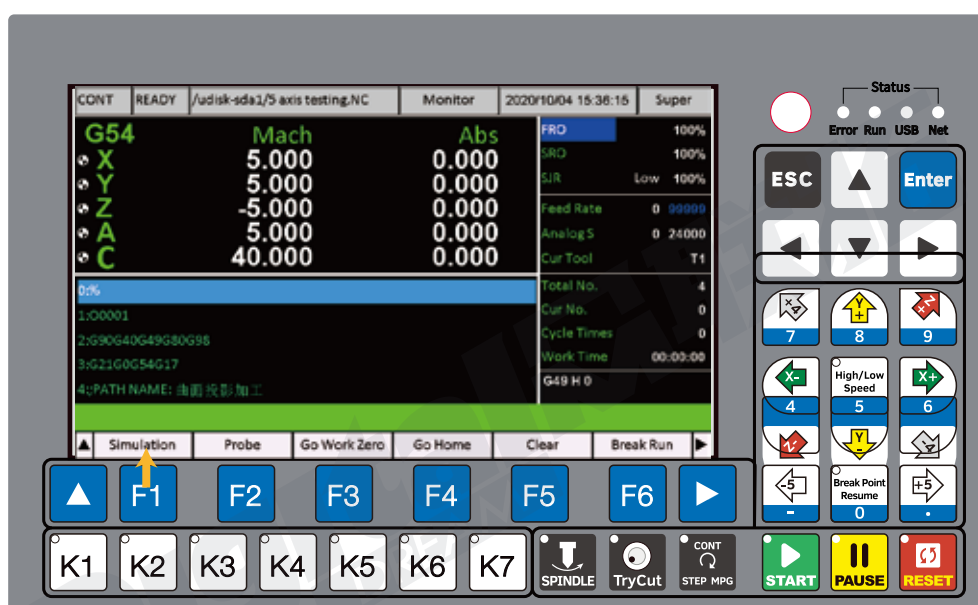

Figure 5-31 In the First Sub-page of Monitor and press F1 to go to the Simulation Page



Figure 5-32 Simulation Page

Press Start Key and the system start to simulate the G-code file :



Figure 5-33 Simulate a G-code file

Important:

- 1) Some users want that the system simulate the G-code file, but system does not send any signals. Then we need to go to Program file, select the file and simulate.
- 2) If it's first time the controller simulate the G-code file, the screen may not match well with the toolpath screen. But after one time simulation, the system can match the file well with the screen.

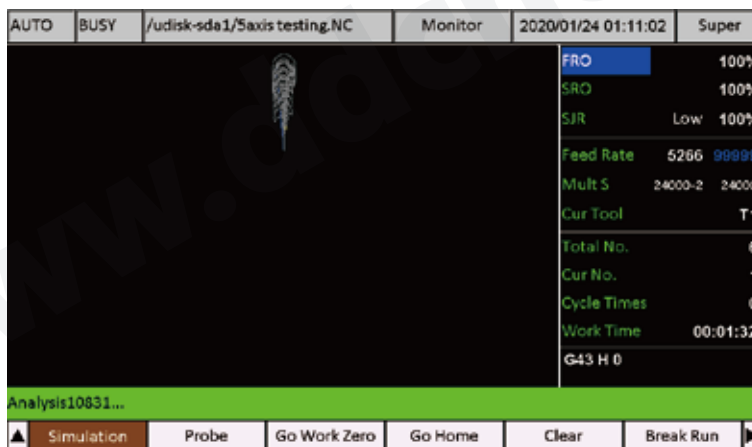

Figure 5-34 System is in Simulation

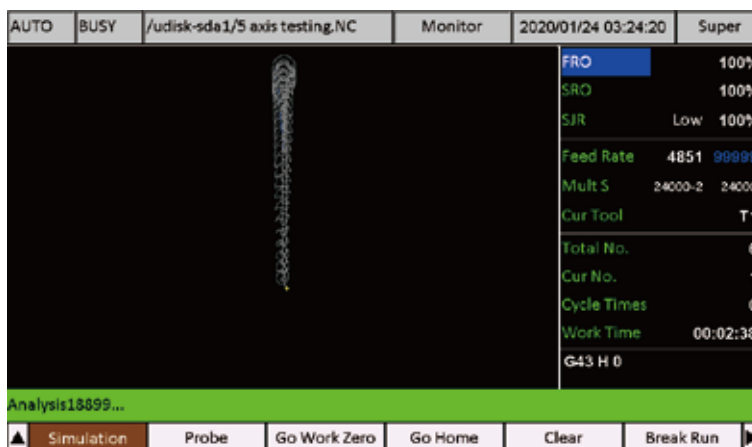

Figure 5-35 System is in Simulation

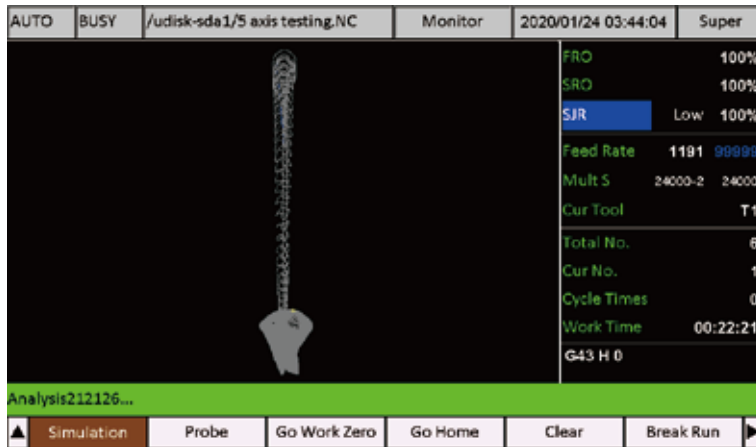

Figure 5-36 System is in Simulation

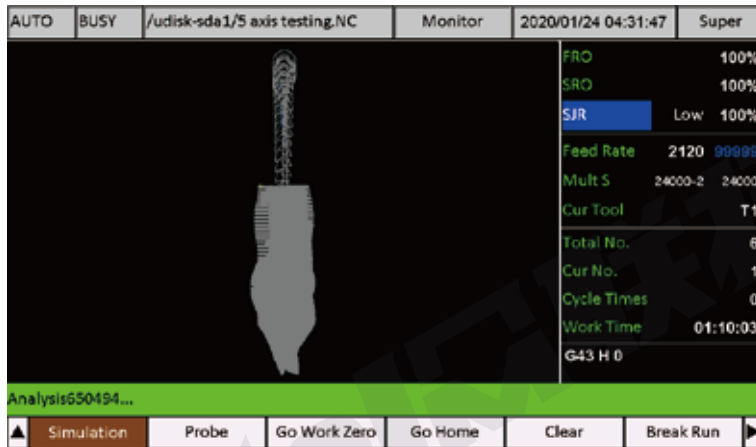

Figure 5-37 System is in Simulation

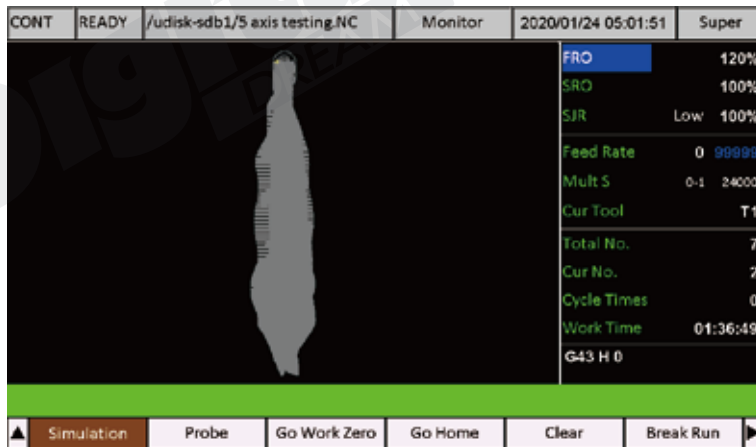

Figure 5-38 Simulation finished

5.3 Probe

The DDCS Expert has two kinds of the Probe mode: Floating Probe and Fix Probe. Firstly we must configurate right input ports to Flloating probe and fix probe in IO page, wire the ports correctly, as the Chapter 4.5 introduced.

CONT	READY	/udisk-scb1/5 axis testing.NC	Monitor	2020/10/04 15:52:07	Super
G54		Mach	Abs	FRO	100%
⊕ X	5.000	0.000	SRO	100%	
⊕ Y	5.000	0.000	SJR	Low	100%
⊕ Z	-5.000	0.000	Feed Rate	0	99999
⊕ A	5.000	0.000	Analog S	0	24000
⊕ C	40.000	0.000	Cur Tool	T1	
Coord:	G54	Fixed Probe X:	5.720		
Cur Tool:	T1	Fixed Probe Y:	-58.053		
THK Of Probe:	10.000	Fixed Probe Z:	-38.677		
1:Before operate [Floating Probe].Pls move tool above the block and set Param 129;				Total No.	4
2:[Fixed Probe]Input the cutter No.,record the offset of Z axis after tool change;				Cur No.	0
3:[Mult Probe] Probe several tools at one time.select the Tools and press [Mult Probe].				Cycle Times	0
				Work Time	00:01:38
				G49 H 0	
▲ Floating Probe		Fixed Probe	Mult Probe	XY Teach	Z Teach

Figure 5-39 Probe Page

5.3.1 Floating Probe

There are many Parameters related to the Floating Probe:

Param #	Definition	Remark
#128	Is the Floating tool set valid?	Enable or Disable the Floating Probe
#129	Floating tool set thickness	Before floating probe,we need to measure out the sensor's thickness and set the #129.
#131	Probing cycle count	The probe times.When the user active the Probe,the system can probe 1 - 5 times as what the users set. At last system calculate an average value.
#132	Initial speed of Probing	The initial down speed of the Z axis after starting the tool setting.
#140	Retraction distance after the end of probe	This parameter is relative.
#63	G00 speed	Here the G00 is the probe speed.

Step 1: Firstly we must configurate the IO port,and wire the cables properly;

Step 2: We set the #128 to Yes,and we measure out the Tool sensor's thickness and set #129, and other parameters above;

Now we start to floating probe.

Firstly we must move the tool above the sensor manually.

We press F1 Key to active the floating probe, the system pops up a window to ask if the tool is just above the sensor,we press Enter the cutter start to probe down. It will probe the times we set, and calculate an average value, then the cutter retract a distance.Then the Floating probe finished.

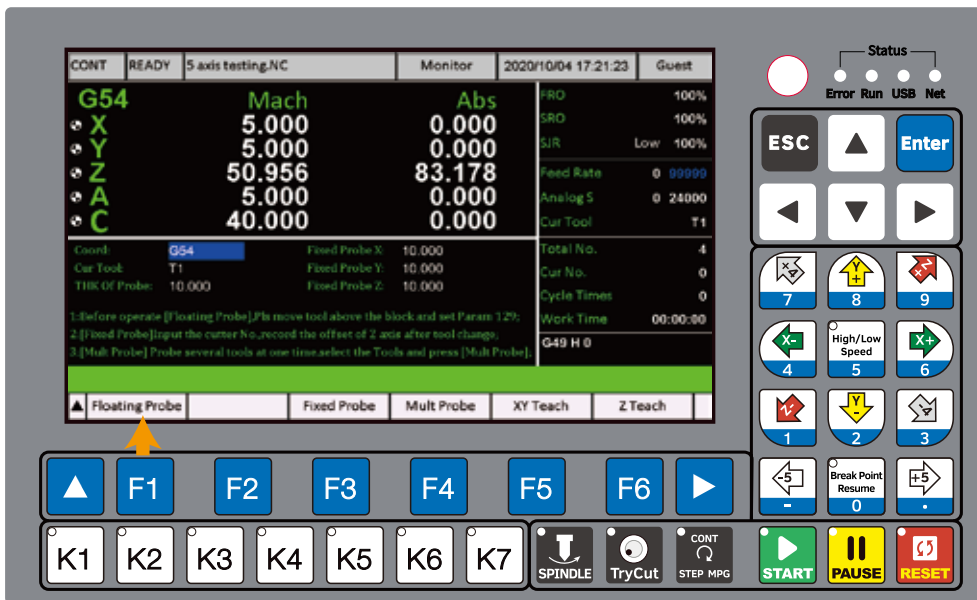

Figure 5-40 Floating Probe

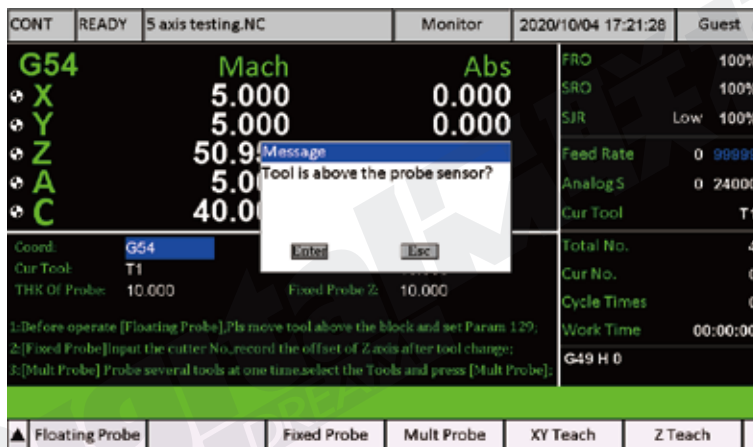

Figure 5-41 Star to Floating Probe

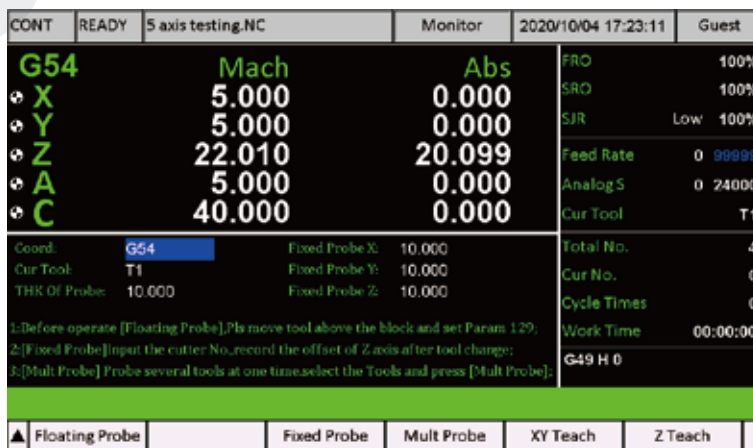

Figure 5-42 Floating Probe Finished

5.3.2 Fixed Probe

There are many Parameters related to the Fixed Probe:

	Definition	Remark	Range
#130	Is the fixed tool set valid?	Enable or Disable the Floating Probe	Yes/No
#131	Probing cycle count	The probe times. When the user active the Probe, the system can probe 1 - 5 times as what the users set. At last system calculate an average value.	1-5
#132	Initial speed of Probing	The initial down speed of the Z axis after starting the tool setting.	99 - 99999mm
#135	Fixed probe X mach position	The initial Position of X axis in Mach coordinate	-9999 ~ 9999mm
#136	Fixed probe Y mach position	The initial Position of Y axis in Mach coordinate	-9999 ~ 9999mm
#137	Fixed probe Z mach position	The initial Position of Z axis in Mach coordinate	-9999 ~ 9999mm
#138	Fixed probe 4th mach position	The initial Position of 4th axis in Mach coordinate	-9999 ~ 9999mm
#139	Fixed probe 5th mach position	The initial Position of 5th axis in Mach coordinate	-9999 ~ 9999mm
#140	Retraction distance after the end of probe	This parameter is relative.	0 - 999 mm
#63	G00 speed	Here the G00 is the probe speed.	99 - 99999

Step 1: Firstly we must configurate the IO port, and wire the cables properly;

Step 2: We set the #130 to Yes;

Step 3: Set the parameter #135 / 136 / 137 / 138 / 139 to find an initial position of probe tool;

Step 4: And set other parameters according to your request above;

Now we start to Fixed probe.

We press F3 Key to active the fixed probe, the system pops up a window to ask you to type in right Tool Number, we press Enter, the system start to Fix probe.

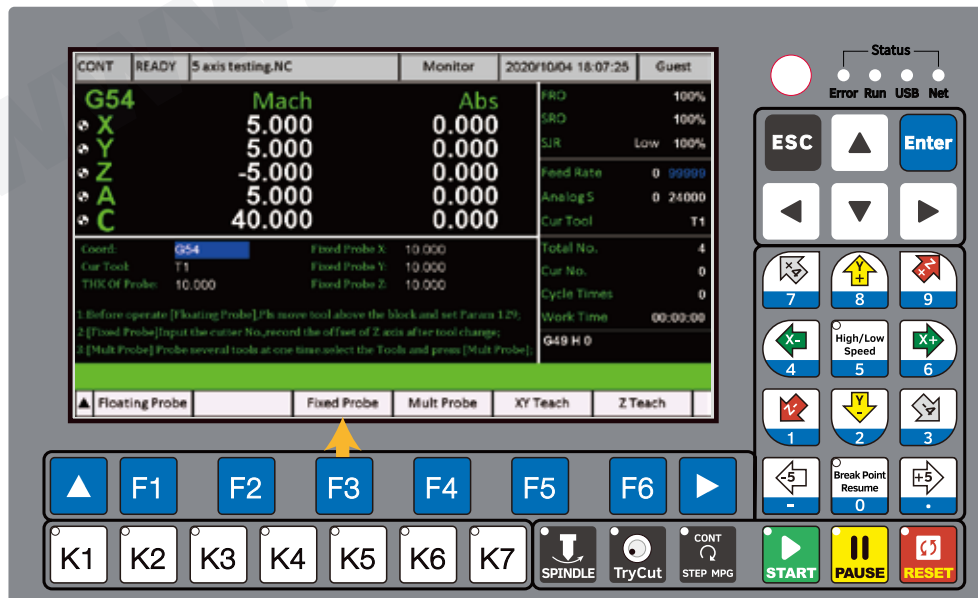

Figure 5-43 Fixed Probe

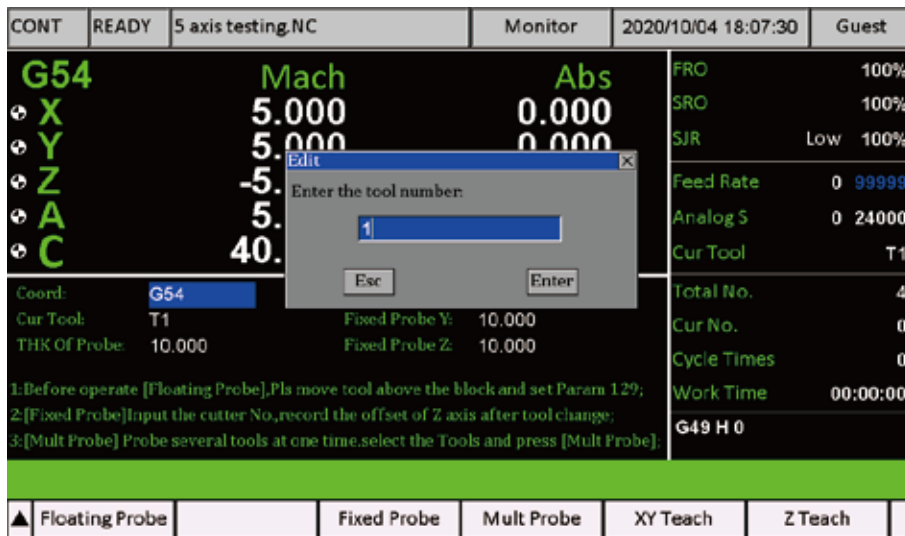

Figure 5-44 Type In the tool number and Enter

The X / Y / Z / 4th / 5th start to move to the initial position in Mach coordinate. After arriving at that position, it starts to probe down. It will probe the times as we set, and calculate an average value, and the cutter retracts a distance. Then the fixed probe is finished.

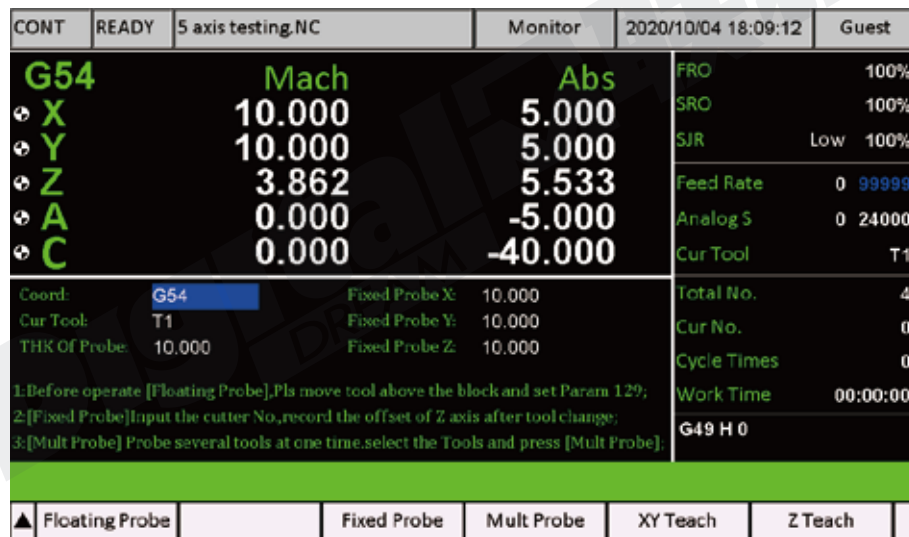

Figure 5-45 Fixed Probe Finished

The probe sequence of each axis is: Z axis -- X axis -- Y axis -- 4th axis -- 5th axis.

5.4 Go work Zero

In the Monitor Page, Press F3 to go to “Go work Zero ” Page.

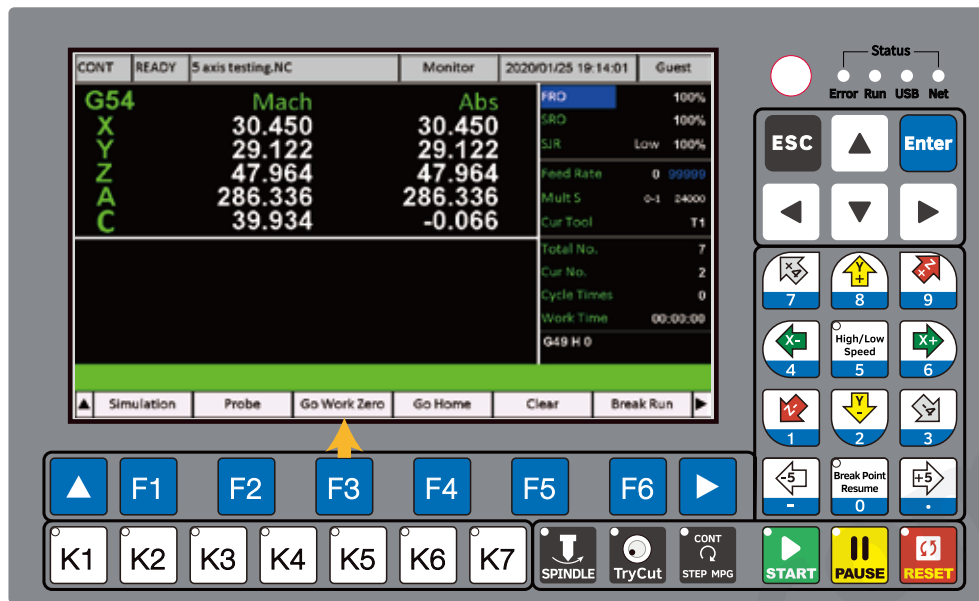

Figure 5-46 Go work Zero Page

Here the users can choose single axis go to zero, or can choose the All axis go to zero. In our example here we press F6 to “All go Zero ”.

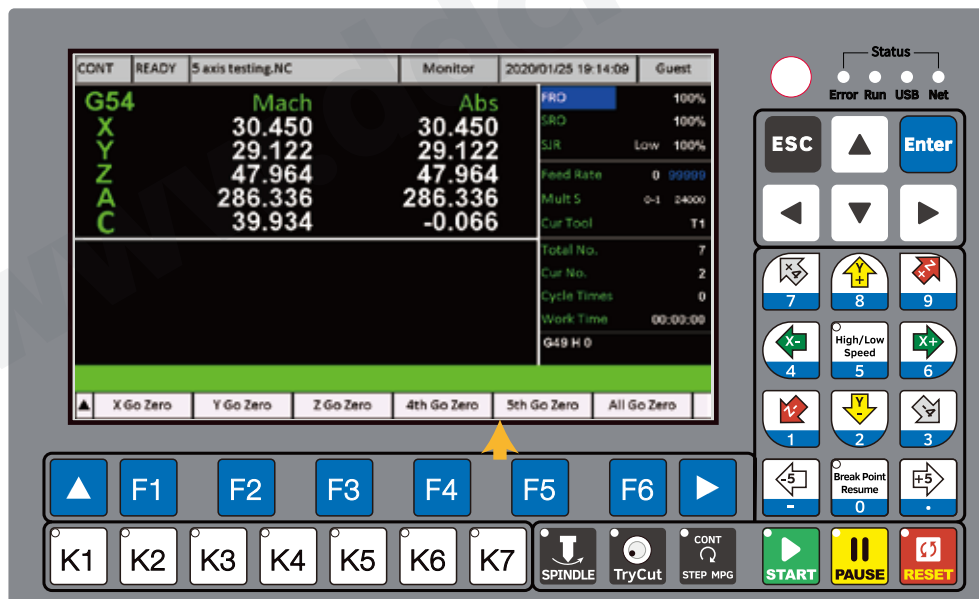

Figure 5-47 Sub-page of Go Work Zero

CONT	READY	5 axis testing,NC	Monitor	2020/01/25 19:14:20	Guest
G54	Mach	Abs	FRO	100%	
X	0.000	0.000	SRO	100%	
Y	0.000	0.000	SJR	Low 100%	
Z	5.000	5.000	Feed Rate	0 99999	
A	0.000	0.000	Mult S	0-1 24000	
C	39.934	-0.066	Cur Tool	T1	
			Total No.	7	
			Cur No.	2	
			Cycle Times	0	
			Work Time	00:00:00	
			G49 H 0		
▲	X Go Zero	Y Go Zero	Z Go Zero	4th Go Zero	5th Go Zero All Go Zero

Figure 5-48 All axis Go Zero

5.5 Go Home

Firstly no forget to go to IO page to configurate right ports for the X / Y / Z / 4th / 5th axis, and wire them correctly. Then we can start to Home.

There are many Parameters related to the Home function, we need to understand them and try to set each parameters correctly for our own usage.

Param #	Definition	Remark	Range
#100	Home mode	There are two mode of Home Mode, Here we only introduce Swtich Mode. If the users need Absolute mode, please contact our engineer to configurate.	Switch/Absolute
#106	Homing cycle count	Detection Times of Home action	1~5
#107	X-axis homing speed	X-axis initial speed when Home	99~99999 mm/min
#108	Y-axis homing speed	Y-axis initial speed when Home	99~99999 mm/min
#109	Z-axis homing speed	Z-axis initial speed when Home	99~99999 mm/min
#110	4th-axis homing speed	4th-axis initial speed when Home	99~99999 mm/min
#111	5th-axis homing speed	5th-axis initial speed when Home	99~99999 mm/min
#112	X-axis homing direction	The movement direction when Home of X-axis	Negative/Positive
#113	Y-axis homing direction	The movement direction when Home of Y-axis	Negative/Positive
#114	Z-axis homing direction	The movement direction when Home of Z-axis	Negative/Positive
#115	4th-axis homing direction	The movement direction when Home of 4th-axis	Negative/Positive
#116	5th-axis homing direction	The movement direction when Home of 5th-axis	Negative/Positive
#122	Mach position after X go home	X / Y / Z / 4th / 5th-axis Position in Mach Coordinate after Home. After all axis finished Homing,they will move to the according position we set here. The values are in Mach coordinate.	-999~999mm
#123	Mach position after Y go home		
#124	Mach position after Z go home		
#125	Mach position after 4th go home		
#126	Mach position after 5th go home		
#127	Home after booting	Whether pop-up a dialog box to ask if Go Home when Power On the Controller.	Yes/No
#235	X-axis Mach zero offset	We can reduce the error made by machine struction or any other factors by setting the offset for each axis.	-999~999mm
#236	Y-axis Mach zero offset		
#237	Z-axis Mach zero offset		
#238	4th-axis Mach zero offset		
#239	5th-axis Mach zero offset		

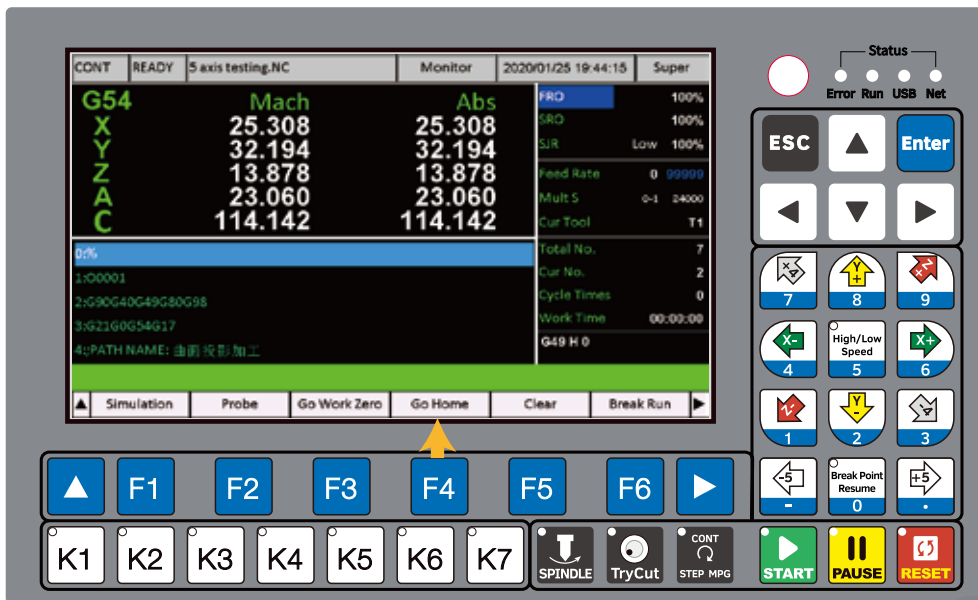

Figure 5-49 In Monitor Page Press F4 to “Go Home”

Here we can choose the single axis to Home, or we can All axis go home. In our example here, we choose the “All Go Home” by F6.

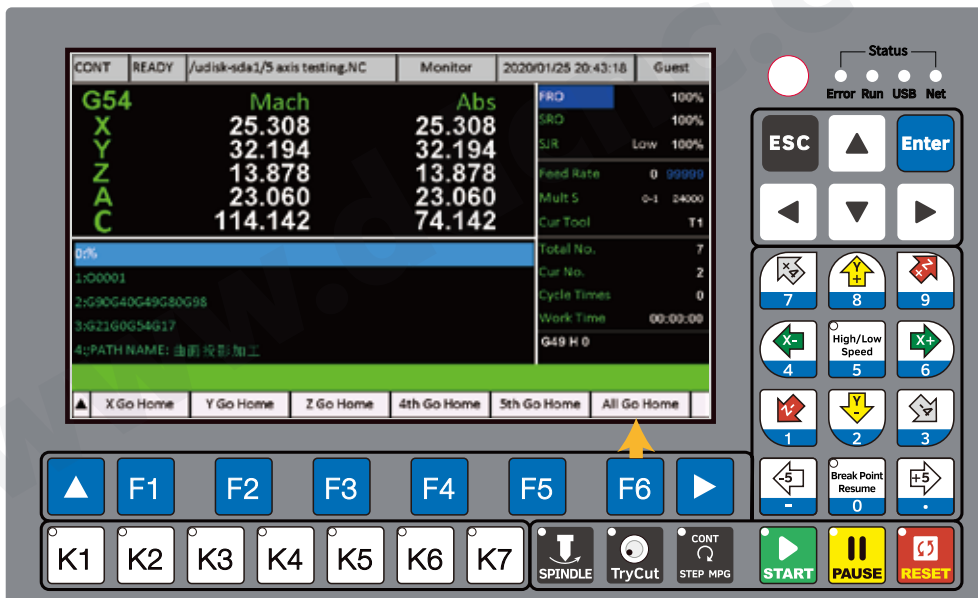

Figure 5-50 All go Home by F6





As figure 5-52 showed, when the system finished Homing, that little symbol will appear on the related axis.

If the users only Home X axis, then only X axis has that symbol; If the users home all axis, all axis have that symbol. By the symbol, the users easily knows the machine was home or not.

Figure 5-52 Home Finished Symbol

So now we can see that our Homing action finished. Now the current position of each axis are not zero but like the figure 5-53. Because we already set the Parameters as below:

CONT	READY	5 axis testing.NC	Param	2020/01/25 21:05:40	Super
Param List:					
		No.	Note	Value	
Machine		0114	Z-axis homing direction	Positive	
Manual		0115	4th-axis homing direction	Negative	
		0116	5th-axis homing direction	Negative	
Process		0122	Mach position after X go home	10.000	
Spindle		0123	Mach position after Y go home	10.000	
		0124	Mach position after Z go home	5.000	
IO		0125	Mach position after 4th go home	20.000	
Home		0126	Mach position after 5th go home	42.000	
Probe		0127	Home after booting	Yes	
		0235	X-axis Mach zero offset	0.000	
Hard Limit		0236	Y-axis Mach zero offset	0.000	
Software limit		0237	Z-axis Mach zero offset	0.000	
		0238	4th-axis Mach zero offset	0.000	
MFG		0239	5th-axis Mach zero offset	0.000	
Backlash					
Tools		Range:	[-999.000 -999.000] mm	Active:	Immediately
System		Details:	Mach position.	User:	Operator

Figure 5-53 Mach Position after Home

We already set the Mach position after Homing. So when the system finished Homing, it will continue to move to the position which we set, this is the same function of Back distance after Home from DDCS V3.1.

We have a parameter also need to be noted also: #106 Homing cycle count, it is the Home times for each axis. For example, if we set 2 times, the each axis will go to the limited switch to be detected by two times.

Everytime we power on the controller DDCS-Expert, the system will pop-up a diagram as Figure 5-54, that is because of #127 "Home after booting". If we don't need it, we just disable it.



Figure 5-54 System ask If go to Home when Power on

The Home sequence is: Z Axis -- X axis -- Y axis -- 4th axis -- 5th axis.

5.6 Clear

In the Monitor Page, Press F5 to go to “Clear” Page.

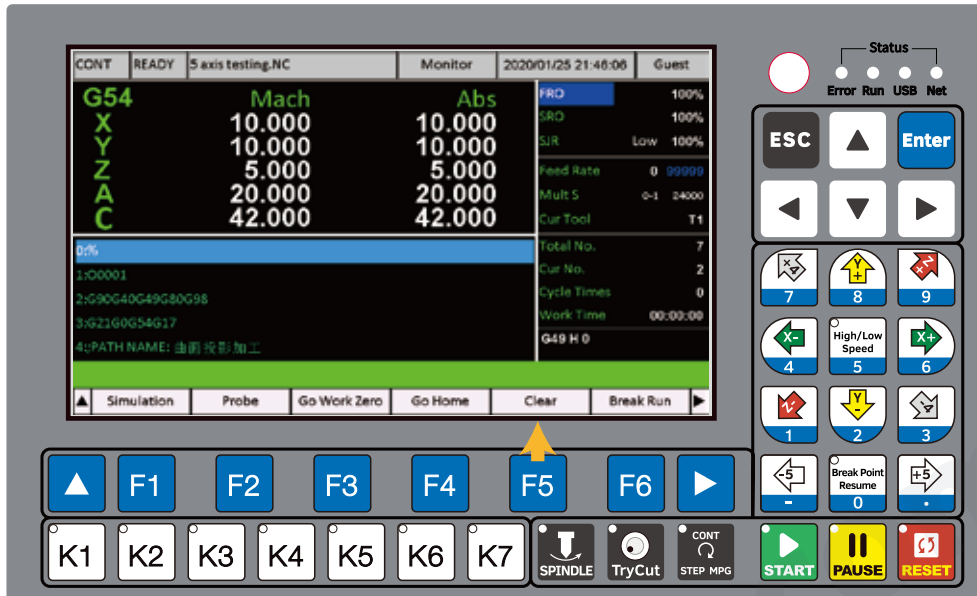

Figure 5-55 Go to “Clear” Page

Here the users can choose single axis go CLEAR, or can choose the All axis CLEAR. In our example here we press F6 to “Clear All”.

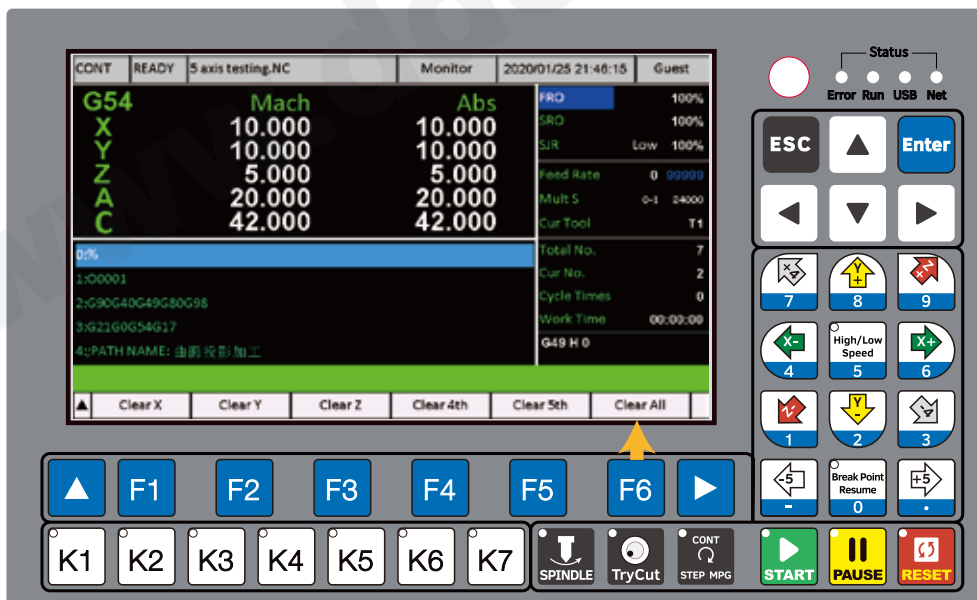

Figure 5-56 Sub-page of CLEAR



Figure 5-57 Clear All axis

5.7 Break Run (Breakpoint Resume)

In the Monitor Page and we Press F6 to enter into the “Break Run” page:



Figure 5-58 “Break Run” Page

As for the breakpoint resume function, we have 3 kinds breakpoint resume:

- 1) Start Line: Start from a specific line; the line number range from 1 - 10,000,000 lines;
- 2) Power Resume: Power Cut off recovery. When the power cut off, the system can remember the line when power cut off, and create a breakpoint.
- 3) Pause Resume: When pause the processing, the system remember the line when pause, and create a breakpoint.

In the Sub-page of “ Break Run ”, we press F1, the system will pop up a window to ask the user to input the start line no. We write in numbers and press enter, system will start to work from this specific line.

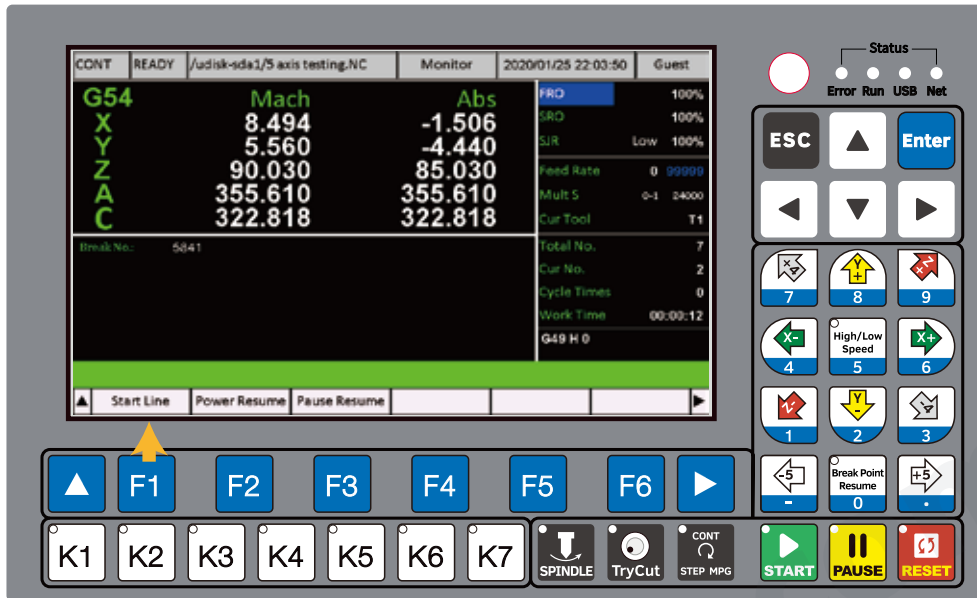

Figure 5-59 Start from a specific line



Figure 5-60 Input the line number

After power cut off or Pause, the controller can create a breakpoint number:



Figure 5-61 Breakpoint Line No.

If it is Power breakpoint, press F2, the system can power cut off recovery;
If it is Pause Resume, Press F3, the system will Pause breakpoint resume.

5.8 Manual

In the Monitor Page and we press  key to go to the second page of Monitor.

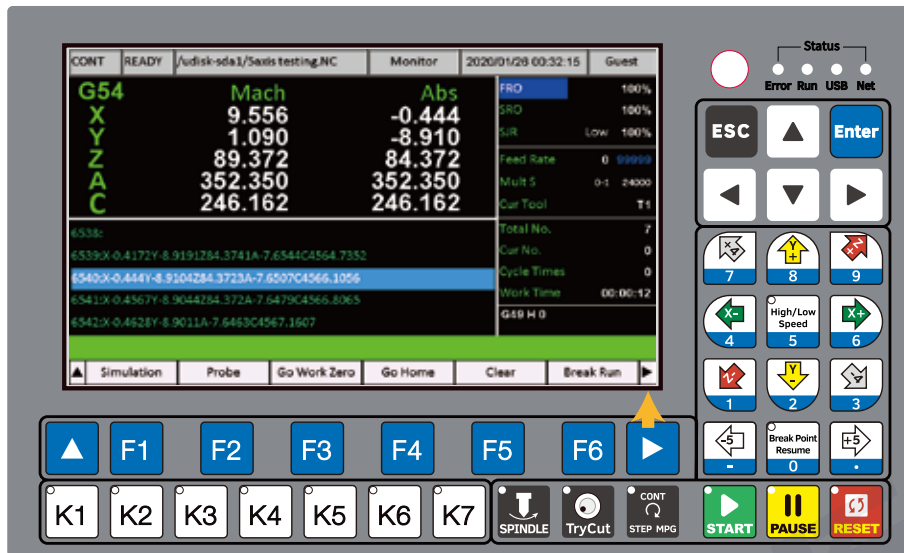

Figure 5-62 Go to second page of Monitor

Then we press F1 key to go to “Manual” Page.

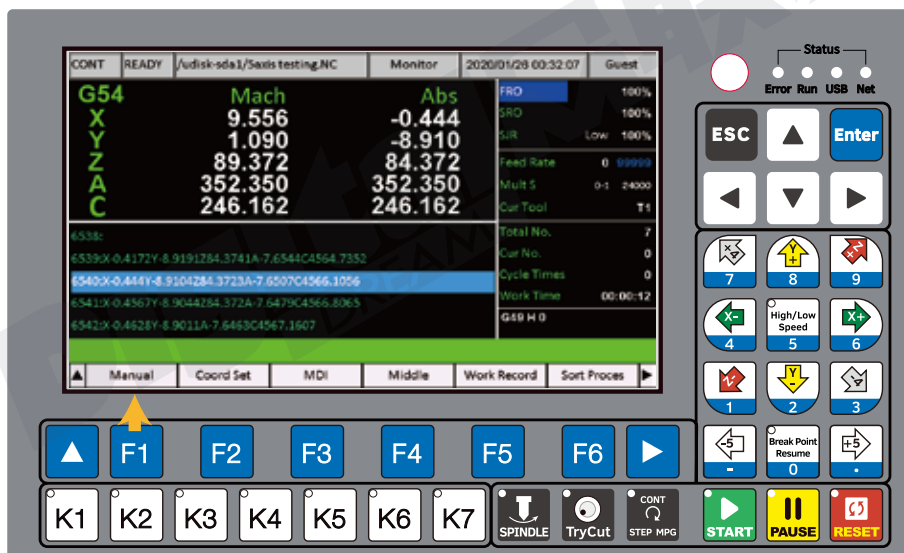

Figure 5-63 Press F1 key to Manual Page

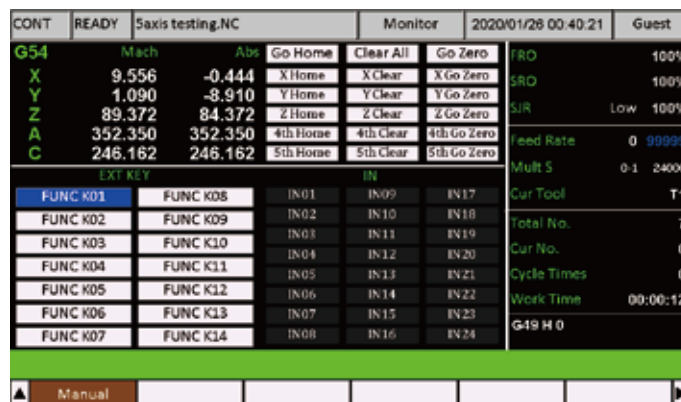

Figure 5-64 Manual Page
Page-60

In Manual page, we can operate some simple functions as: Home, Clear and Zero; We can check the input ports status, to check it is conducting or not. And there is 14 virtual keys, by which, the users can define them as what they want.

By the Rotary button (Knob)  or the  and  keys, we can shift among the different blocks.

CONT	READY	Saxis testing.NC	Monitor			2020/01/26 00:41:54	Guest
G54	Mach	Abs	Go Home	Clear All	Go Zero	FRO	100%
X	10.000	0.000	X Home	X Clear	X Go Zero	SRO	100%
Y	10.000	0.000	Y Home	Y Clear	Y Go Zero	SJR	Low 100%
Z	5.000	0.000	Z Home	Z Clear	Z Go Zero	Feed Rate	0 99999
A	20.000	20.000	4th Home	4th Clear	4th Go Zero	Mult S	0-1 24000
C	42.000	42.000	5th Home	5th Clear	5th Go Zero	Cur Tool	T1
EXT KEY			IN			Total No.	7
FUNC K01	FUNC K08		IN01	IN09	IN17	Cur No.	0
FUNC K02	FUNC K09		IN02	IN10	IN18	Cycle Times	0
FUNC K03	FUNC K10		IN03	IN11	IN19	Work Time	00:00:12
FUNC K04	FUNC K11		IN04	IN12	IN20	G49 H 0	
FUNC K05	FUNC K12		IN05	IN13	IN21		
FUNC K06	FUNC K13		IN06	IN14	IN22		
FUNC K07	FUNC K14		IN07	IN15	IN23		
			IN08	IN16	IN24		
Manual							

Figure 5-65 Here we can operate these functions

CONT	READY	Saxis testing.NC	Monitor			2020/01/26 00:41:50	Guest
G54	Mach	Abs	Go Home	Clear All	Go Zero	FRO	100%
X	10.000	0.000	X Home	X Clear	X Go Zero	SRO	100%
Y	10.000	0.000	Y Home	Y Clear	Y Go Zero	SJR	Low 100%
Z	5.000	0.000	Z Home	Z Clear	Z Go Zero	Feed Rate	0 99999
A	20.000	20.000	4th Home	4th Clear	4th Go Zero	Mult S	0-1 24000
C	42.000	42.000	5th Home	5th Clear	5th Go Zero	Cur Tool	T1
EXT KEY			IN			Total No.	7
FUNC K01	FUNC K08		IN01	IN09	IN17	Cur No.	0
FUNC K02	FUNC K09		IN02	IN10	IN18	Cycle Times	0
FUNC K03	FUNC K10		IN03	IN11	IN19	Work Time	00:00:12
FUNC K04	FUNC K11		IN04	IN12	IN20	G49 H 0	
FUNC K05	FUNC K12		IN05	IN13	IN21		
FUNC K06	FUNC K13		IN06	IN14	IN22		
FUNC K07	FUNC K14		IN07	IN15	IN23		
			IN08	IN16	IN24		
Manual							

Figure 5-66 The Monitor or the Input ports: IN01-09 are conducting, IN17 to IN24 no conducting

There are 14 virtual keys we can define the function in Slib-m.nc file. "Slib-m.nc" file can be found in the INSTALL folder for DDCS-Expert.

CONT	READY	Saxis testing.NC	Monitor			2020/01/26 00:41:54	Guest
G54	Mach	Abs	Go Home	Clear All	Go Zero	FRO	100%
X	10.000	0.000	X Home	X Clear	X Go Zero	SRO	100%
Y	10.000	0.000	Y Home	Y Clear	Y Go Zero	SJR	Low 100%
Z	5.000	0.000	Z Home	Z Clear	Z Go Zero	Feed Rate	0 99999
A	20.000	20.000	4th Home	4th Clear	4th Go Zero	Mult S	0-1 24000
C	42.000	42.000	5th Home	5th Clear	5th Go Zero	Cur Tool	T1
EXT KEY			IN			Total No.	7
FUNC K01	FUNC K08		IN01	IN09	IN17	Cur No.	0
FUNC K02	FUNC K09		IN02	IN10	IN18	Cycle Times	0
FUNC K03	FUNC K10		IN03	IN11	IN19	Work Time	00:00:12
FUNC K04	FUNC K11		IN04	IN12	IN20	G49 H 0	
FUNC K05	FUNC K12		IN05	IN13	IN21		
FUNC K06	FUNC K13		IN06	IN14	IN22		
FUNC K07	FUNC K14		IN07	IN15	IN23		
			IN08	IN16	IN24		
Manual							

5.9 Coord Set

Then we press F2 key to go to “Coord Set” Page. In the Coord Set Page, we can Select coordinate, and also we can edit the offset between the G54 / G55 / G56 / G57 / G58 / G59 and Mechanical Coordinate.

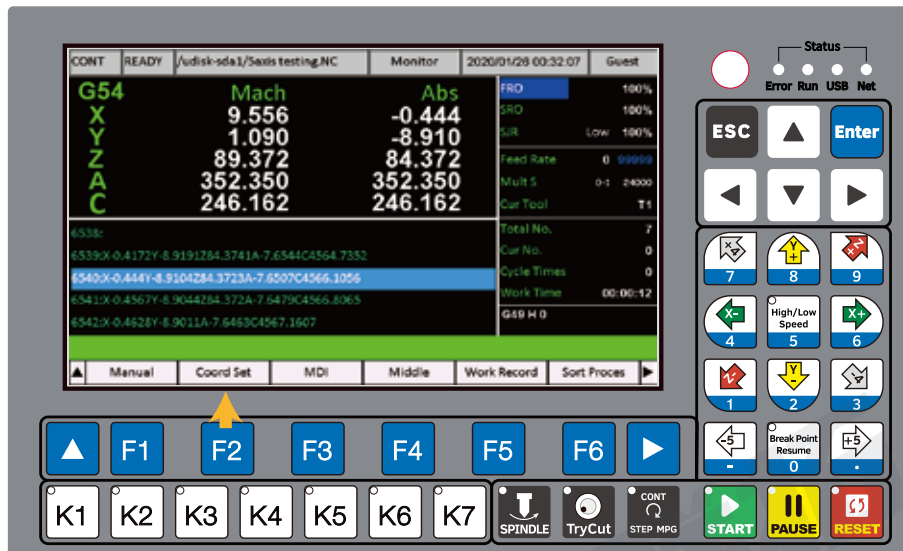

Figure 5-68 Press F1 key to “Coord Set” Page

In the first Page, there is functions as:Select Coord / Clear X / Clear Z / Z Step / Deeper:

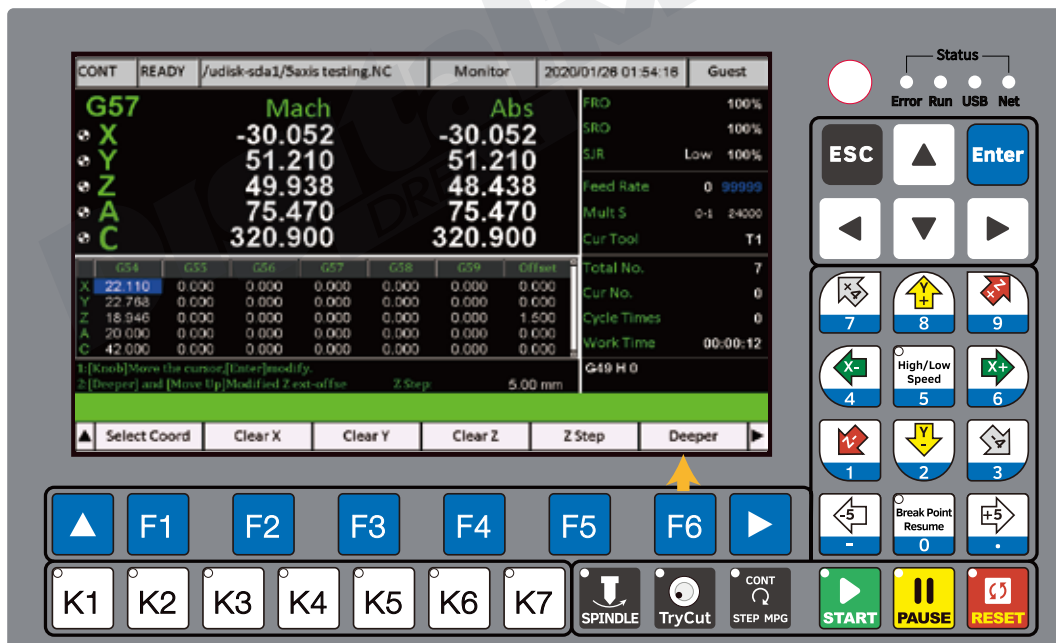



Figure 5-69 First Page of Coord Set

We Press the  Key to go to the second page of Coord Set:

In the second page,there are function as Move Up / Clear 4th / Clear 5th.

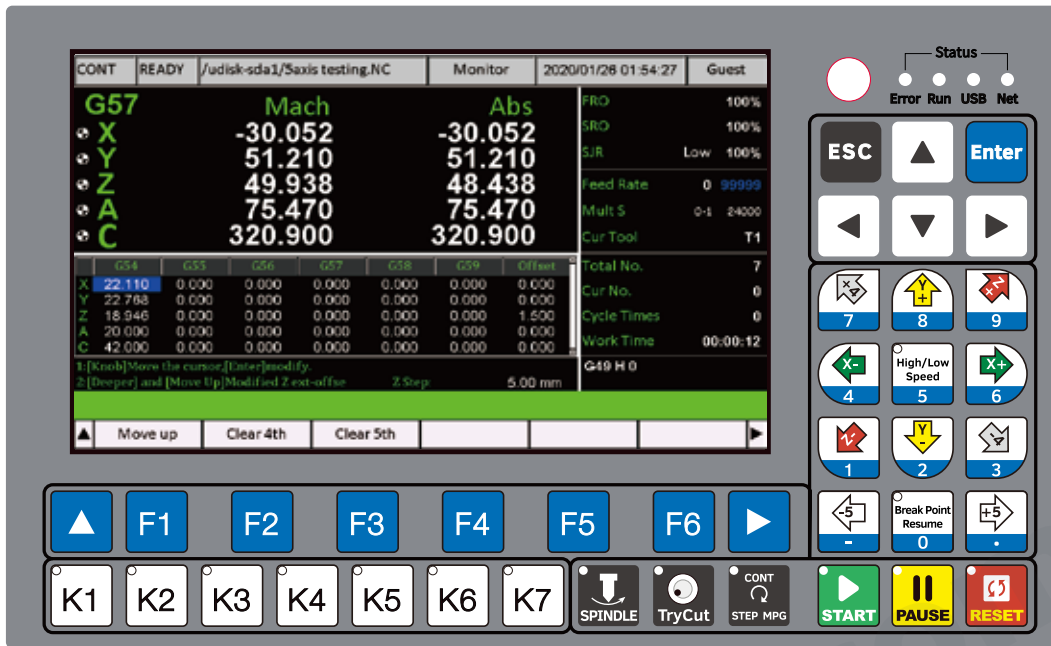

Figure 5-70 Second Page of Coor Set

5.9.1 Select Coord

By the Rotary button(Knob)  or the  and  keys,wen can shift among the different blocks. We select the block,and press Enter or knob,then we can write in numbers.

So we can move our cursor to any Coordinate, and we press “Select Coord”, then the current coordinate is the one we choose.

For example, we move the cursor to any block on G57, and we press “Select Coord” key, then the current Coordinate change from G54 to G57:



Figure 5-71 Current Coordinate is G54

CONT	READY	/udisk-sda1/5axis testing.NC	Monitor	2020/01/26 01:54:27	Guest				
G57		Mach	Abs	FRO	100%				
X		-30.052	-30.052	SRO	100%				
Y		51.210	51.210	SJR	Low 100%				
Z		49.938	48.438	Feed Rate	0 99999				
A		75.470	75.470	Mult S	0-1 24000				
C		320.900	320.900	Cur Tool	T1				
	G54	G55	G56	G57	G58	G59	Offset	Total No.	7
X	22.110	0.000	0.000	0.000	0.000	0.000	0.000	Cur No.	0
Y	22.768	0.000	0.000	0.000	0.000	0.000	0.000	Cycle Times	0
Z	18.946	0.000	0.000	0.000	0.000	0.000	1.500	Work Time	00:00:12
A	20.000	0.000	0.000	0.000	0.000	0.000	0.000	G49 H 0	
C	42.000	0.000	0.000	0.000	0.000	0.000	0.000		
1:[Knob]Move the cursor,[Enter]modify.									
2:[Deeper] and [Move Up]Modified Z ext-offse								Z Step	5.00 mm
▲	Move up	Clear 4th	Clear 5th						▶

Figure 5-72 Select the Coordinate to G57

5.9.2 Clear X / Y / Z / 4th / 5th Axis

When we move the cursor to any block of the coordinate, this coordinate is selected. Then we press “Clear X”, then the X axis value is cleared, and the X axis offset in G57 is created.

CONT	READY	5axis testing.NC	Monitor	2020/01/26 02:24:32	Guest				
G57		Mach	Abs	FRO	100%				
X		-30.052	0.000	SRO	100%				
Y		50.056	50.056	SJR	Low 100%				
Z		57.652	-1.500	Feed Rate	0 99999				
A		75.470	75.470	Mult S	0-1 24000				
C		320.900	320.900	Cur Tool	T1				
	G54	G55	G56	G57	G58	G59	Offset	Total No.	7
X	22.110	0.000	0.000	-30.052	0.000	0.000	0.000	Cur No.	0
Y	22.768	0.000	0.000	0.000	0.000	0.000	0.000	Cycle Times	0
Z	18.946	0.000	0.000	57.652	0.000	0.000	1.500	Work Time	00:00:12
A	0.000	0.000	0.000	0.000	0.000	0.000	0.000	G49 H 0	
C	0.000	0.000	0.000	0.000	0.000	0.000	0.000		
1:[Knob]Move the cursor,[Enter]modify.									
2:[Deeper] and [Move Up]Modified Z ext-offse								Z Step	0.50 mm
▲	Select Coord	Clear X	Clear Y	Clear Z	Z Step	Deeper			▶

Figure 5-73 Clear X in Coordinate 57

Here we took X axis for example.

If the users want to clear other axis, just press the according function key.

5.9.3 Set Z Step

We can set Z step by pressing the “ Z step ” Key (F5). The one step number can be shift among 0.01mm, 0.1mm, 1.00mm, 5.00mm. It’s good both for big distance and small distance setting.

CONT	READY	/udisk-sda1/5axis testing.NC				Monitor	2020/01/26 01:37:25	Guest
G54		Mach			Abs			FRO 100%
⊕ X		-30.052			-52.162			SRO 100%
⊕ Y		51.210			28.442			SJR Low 100%
⊕ Z		49.938			24.492			Feed Rate 0 99999
⊕ A		75.470			55.470			Mult S 0-1 24000
⊕ C		320.900			278.900			Cur Tool T1
	G54	G55	G56	G57	G58	G59	Offset	Total No. 7
X	22.110	0.000	0.000	0.000	0.000	0.000	0.000	Cur No. 0
Y	22.768	0.000	0.000	0.000	0.000	0.000	0.000	Cycle Times 0
Z	18.946	0.000	0.000	0.000	0.000	0.000	6.500	00:00:12
A	20.000	0.000	0.000	0.000	0.000	0.000	0.000	
C	42.000	0.000	0.000	0.000	0.000	0.000	0.000	
1:[Knob]Move the cursor,[Enter]modify.								
2:[Deeper] and [Move Up]Modified Z ext-offse Z Step. 0.01 mm								
								<input type="checkbox"/> 0.10 mm <input type="checkbox"/> 0.50 mm <input type="checkbox"/> 1.00 mm <input type="checkbox"/> 5.00 mm
▲	Select Coord	Clear X	Clear Y	Clear Z	Z Step	Deeper	▶	

Figure 5-74 Sub-page of CLEAR

5.9.4 Deeper and Move up

By the “ Deeper ” and “ Move up ” key we can set the Z axis offset very convenient and easily. Each pressing the Z axis offset will change by the value of “ Z step ” Setting.

5.10 MDI

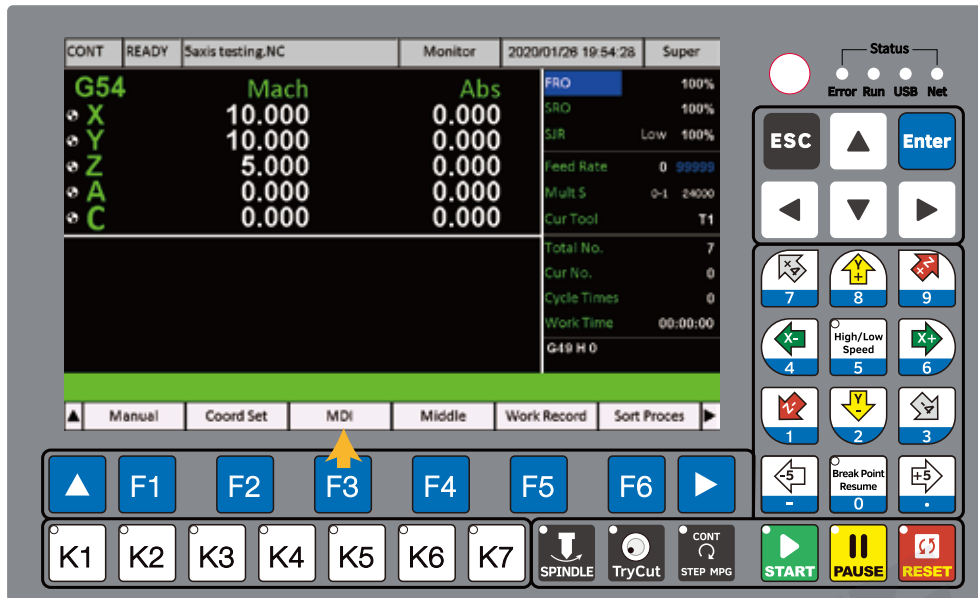

Figure 5-75 Press F3 key to MDI Page

In the MDI Page, we can edit the G-code ourselves with the controller panel. Here we can edit 6 lines G-code by virtual keyboard.

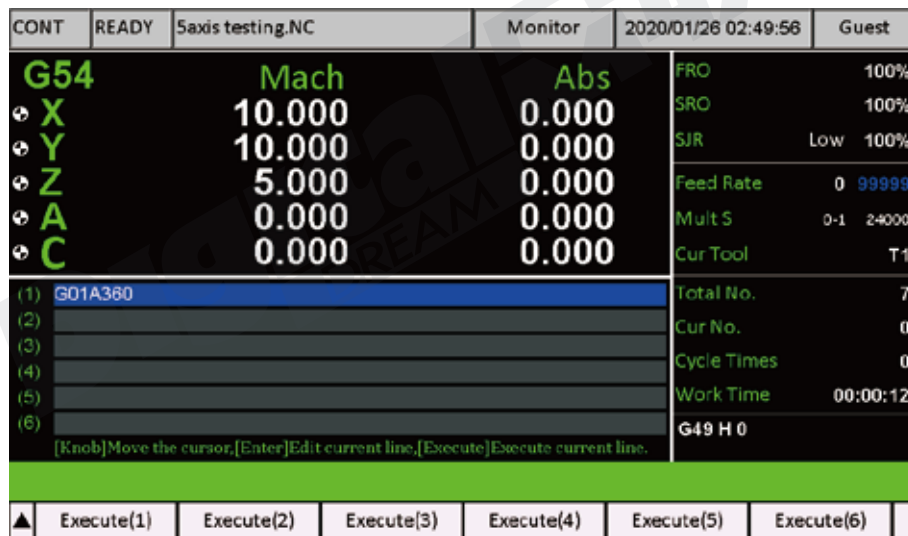





Figure 5-76 MDI Page

By the Rotary button (Knob)  or the  and  keys, we can shift among the different Lines. We move the cursor, select a line and Enter, then the Virtual keyboard is active.

There are 3 pages Virtual keyboard, by the panel Key  we can shift the 3 virtual keyboards.

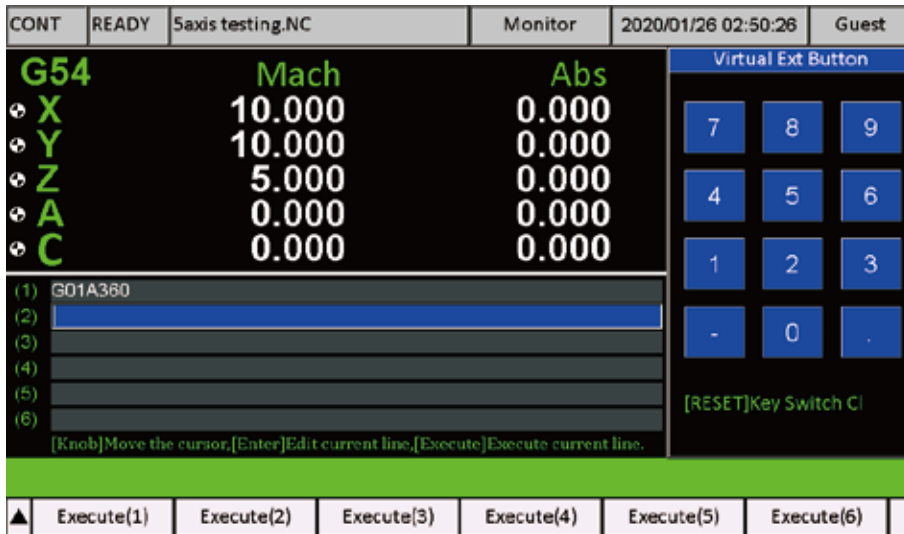

Figure 5-77 Vitul Keyboard is enabled by "Enter"

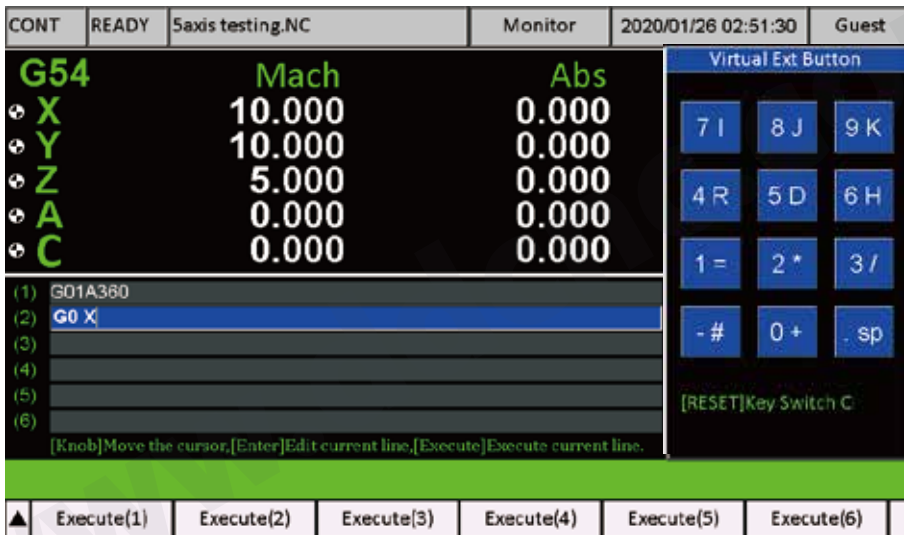

Figure 5-78 Edit a line of G-code

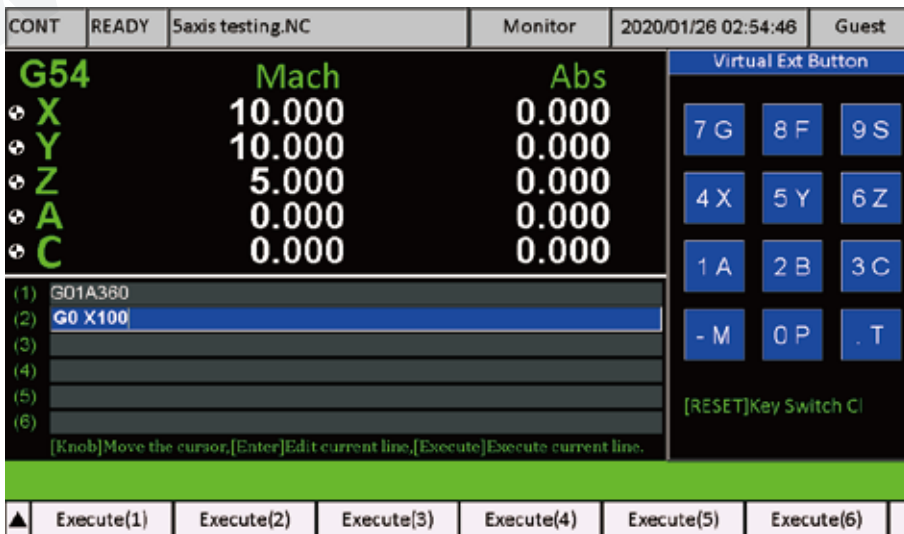
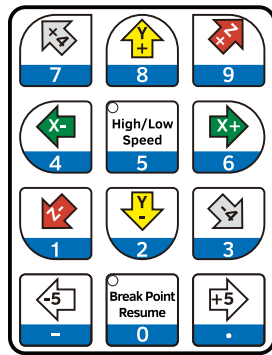

Figure 5-79 Edit a line of G-code with another Vitul keyboard



DDCSE Controller Editing-Panel

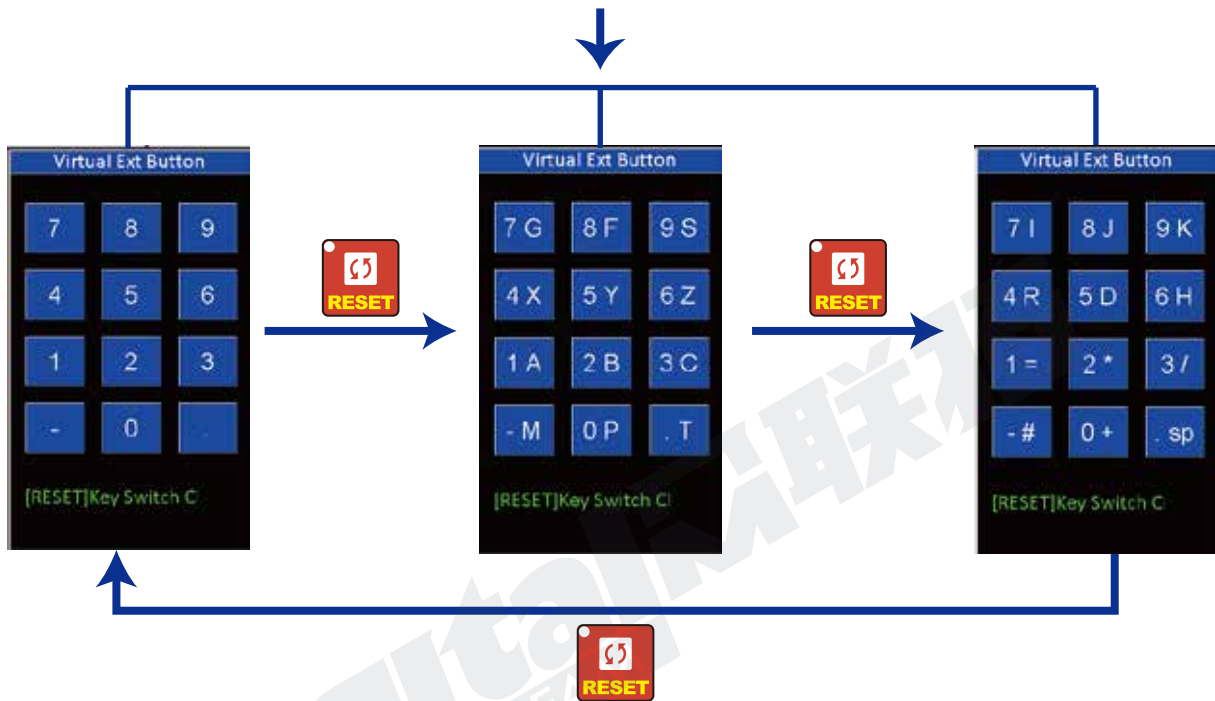

Figure 5-80 The 3 pages virtual keyboard shifted alternately by pressing Reset Key

As the users finished editing the G-code, press "Execute(1)"--"Execute(6)" (F1--F6) to execute the according G-code line.

5.11 Middle



Figure 5-81 Press F4 key to Middle Page



Figure 5-82 Middle Page

DDCS-Expert Controller can support two kinds function:

1) Find a middle point for a line: find the Middle point from two points for X or Y axis. And set the middle point as the Zero in the current workpiece coordinate (G54 - G59) ;

2) Find a middle point for the Arc:find the Middle from 3 points. And set the middle point as the Zero in the current workpiece coordinate (G54 - G59) ;

5.11.1 Find Middle Point in X Axis

In the First Page of Middle, there are 5 functional buttons. Following, we will take example of how to set the Middle to introduce how to use them.

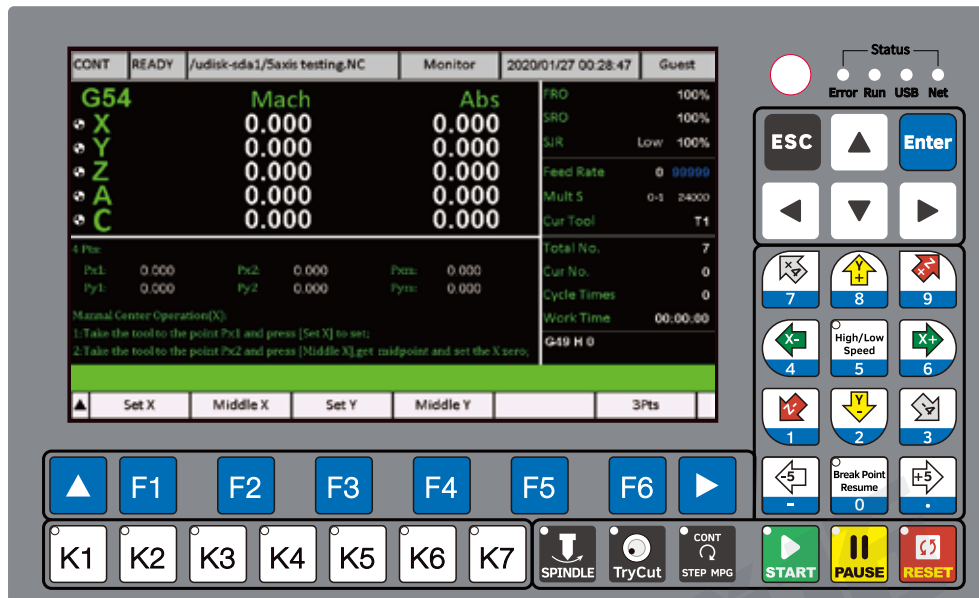

Figure 5-83 Middle Page

Now we set a start point is X = 50, an end point is X = 100. We need to find a Middle from this two point.

Step 1: We move the X axis to X = 50 :



Figure 5-84 X=50

Step 2: Press “ Set X ” (F1)

Then the first point is saved.

CONT	READY	5axis testing.NC	Monitor	2020/01/26 22:52:41	Guest	
G54		Mach	Abs	FRO	100%	
⊕ X		50.000	50.000	SRO	100%	
⊕ Y		0.000	0.000	SJR	Low 100%	
⊕ Z		0.000	0.000	Feed Rate	0 99999	
⊕ A		0.000	0.000	Mult S	0-1 24000	
⊕ C		0.000	0.000	Cur Tool	T1	
4 Pts:				Total No.	7	
	Px1:	50.000	Px2: 0.000	Pxm: 0.000	Cur No.	0
	Py1:	0.000	Py2: 0.000	Pym: 0.000	Cycle Times	0
Manual Center Operation(X):				Work Time	00:00:00	
1: Take the tool to the point Px1 and press [Set X] to set;				G49 H 0		
2: Take the tool to the point Px2 and press [Middle X], get midpoint and set the X zero;						
▲	Set X	Middle X	Set Y	Middle Y	3Pts	

Figure 5-85 First point saved

Step 3: Move the X axis to X = 100 :

CONT	READY	5axis testing.NC	Monitor	2020/01/26 22:52:53	Guest	
G54		Mach	Abs	FRO	100%	
⊕ X		100.000	100.000	SRO	100%	
⊕ Y		0.000	0.000	SJR	Low 100%	
⊕ Z		0.000	0.000	Feed Rate	0 99999	
⊕ A		0.000	0.000	Mult S	0-1 24000	
⊕ C		0.000	0.000	Cur Tool	T1	
4 Pts:				Total No.	7	
	Px1:	50.000	Px2: 0.000	Pxm: 0.000	Cur No.	0
	Py1:	0.000	Py2: 0.000	Pym: 0.000	Cycle Times	0
Manual Center Operation(X):				Work Time	00:00:00	
1: Take the tool to the point Px1 and press [Set X] to set;				G49 H 0		
2: Take the tool to the point Px2 and press [Middle X], get midpoint and set the X zero;						
▲	Set X	Middle X	Set Y	Middle Y	3Pts	

Figure 5-86 X=100

Step 4: Press the “ Middle X ” key (F2), the system will record the second point, and calculate the Middle point, and set this point position as the Zero.

CONT	READY	5axis testing.NC	Monitor	2020/01/26 22:52:57	Guest	
G54		Mach	Abs	FRO	100%	
⊕ X		100.000	25.000	SRO	100%	
⊕ Y		0.000	0.000	SJR	Low 100%	
⊕ Z		0.000	0.000	Feed Rate	0 99999	
⊕ A		0.000	0.000	Mult S	0-1 24000	
⊕ C		0.000	0.000	Cur Tool	T1	
4 Pts:				Total No.	7	
	Px1:	50.000	Px2: 100.000	Pxm: 75.000	Cur No.	0
	Py1:	0.000	Py2: 0.000	Pym: 0.000	Cycle Times	0
Manual Center Operation(X):				Work Time	00:00:00	
1: Take the tool to the point Px1 and press [Set X] to set;				G49 H 0		
2: Take the tool to the point Px2 and press [Middle X], get midpoint and set the X zero;						
▲	Set X	Middle X	Set Y	Middle Y	3Pts	

Figure 5-87 Find Middle Point in X Axis

5.11.2 Find Middle Point in Y Axis

Now we set a start point is $Y = 50$, an end point is $Y = 100$. We need to find a Middle from this two point.

Step 1: We move the Y axis to $Y = 50$:

CONT	READY	5axis testing.NC	Monitor	2020/01/26 22:53:13	Guest	
G54		Mach	Abs			
⊕ X		100.000	25.000	FRO	100%	
⊕ Y		50.000	50.000	SRO	100%	
⊕ Z		0.000	0.000	SJR	Low 100%	
⊕ A		0.000	0.000	Feed Rate	0 99999	
⊕ C		0.000	0.000	Mult S	0-1 24000	
				Cur Tool	T1	
4 Pts:				Total No.	7	
	Px1:	50.000	Px2:	100.000	Pxm:	75.000
	Py1:	0.000	Py2:	0.000	Pym:	0.000
Manual Center Operation(X):				Cur No.	0	
1: Take the tool to the point Px1 and press [Set X] to set;				Cycle Times	0	
2: Take the tool to the point Px2 and press [Middle X], get midpoint and set the X zero;				Work Time	00:00:00	
				G49 H 0		
▲	Set X	Middle X	Set Y	Middle Y	3Pts	

Figure 5-88 X=50

Step 2: Press “ Set Y ” (F3)

Then the first point is saved.

CONT	READY	5axis testing.NC	Monitor	2020/01/26 22:53:16	Guest	
G54		Mach	Abs			
⊕ X		100.000	25.000	FRO	100%	
⊕ Y		50.000	50.000	SRO	100%	
⊕ Z		0.000	0.000	SJR	Low 100%	
⊕ A		0.000	0.000	Feed Rate	0 99999	
⊕ C		0.000	0.000	Mult S	0-1 24000	
				Cur Tool	T1	
4 Pts:				Total No.	7	
	Px1:	50.000	Px2:	100.000	Pxm:	75.000
	Py1:	50.000	Py2:	0.000	Pym:	0.000
Manual Center Operation(X):				Cur No.	0	
1: Take the tool to the point Px1 and press [Set X] to set;				Cycle Times	0	
2: Take the tool to the point Px2 and press [Middle X], get midpoint and set the X zero;				Work Time	00:00:00	
				G49 H 0		
▲	Set X	Middle X	Set Y	Middle Y	3Pts	

Figure 5-89 First point saved

Step 3: Move the Y axis to Y = 100 :

CONT	READY	Saxis testing.NC	Monitor	2020/01/26 22:53:31	Guest
G54		Mach	Abs	FRO	100%
⊕ X		100.000	25.000	SRO	100%
⊕ Y		100.000	100.000	SJR	Low 100%
⊕ Z		0.000	0.000	Feed Rate	0 99999
⊕ A		0.000	0.000	Mult S	0-1 24000
⊕ C		0.000	0.000	Cur Tool	T1
4 Pts:				Total No.	7
Px1:	50.000	Px2:	100.000	Pxm:	75.000
Py1:	50.000	Py2:	0.000	Pym:	0.000
Manual Center Operation(X):				Cur No.	0
1: Take the tool to the point Px1 and press [Set X] to set;				Cycle Times	0
2: Take the tool to the point Px2 and press [Middle X], get midpoint and set the X zero;				Work Time	00:00:00
				G49 H 0	
▲	Set X	Middle X	Set Y	Middle Y	3Pts

Figure 5-90 Y=100

Step 4: Press the “ Middle Y ” key (F4), the system will record the second point, and calculate the Middle point, and set this middle point position as the Zero.

CONT	READY	Saxis testing.NC	Monitor	2020/01/26 22:53:35	Guest
G54		Mach	Abs	FRO	100%
⊕ X		100.000	25.000	SRO	100%
⊕ Y		100.000	25.000	SJR	Low 100%
⊕ Z		0.000	0.000	Feed Rate	0 99999
⊕ A		0.000	0.000	Mult S	0-1 24000
⊕ C		0.000	0.000	Cur Tool	T1
4 Pts:				Total No.	7
Px1:	50.000	Px2:	100.000	Pxm:	75.000
Py1:	50.000	Py2:	100.000	Pym:	75.000
Manual Center Operation(X):				Cur No.	0
1: Take the tool to the point Px1 and press [Set X] to set;				Cycle Times	0
2: Take the tool to the point Px2 and press [Middle X], get midpoint and set the X zero;				Work Time	00:00:00
				G49 H 0	
▲	Set X	Middle X	Set Y	Middle Y	3Pts

Figure 5-91 Find Middle point in Y axis

4 Pts:					
Px1:	50.000	Px2:	100.000	Pxm:	75.000
Py1:	50.000	Py2:	100.000	Pym:	75.000

- Px1 = First point Position in X Axis in Mechanical Coordinate;
- Py1 = First point Position in Y Axis in Mechanical Coordinate;
- Px2 = The second point Position in X Axis in Mechanical Coordinate;
- Py2 = The second point Position in Y Axis in Mechanical Coordinate;
- Pxm = The Middle Point Position in X Axis in Mechanical Coordinate;
- Pym = The Middle Point Position in Y Axis in Mechanical Coordinate.

5.11.3 Find a middle point for the Arc

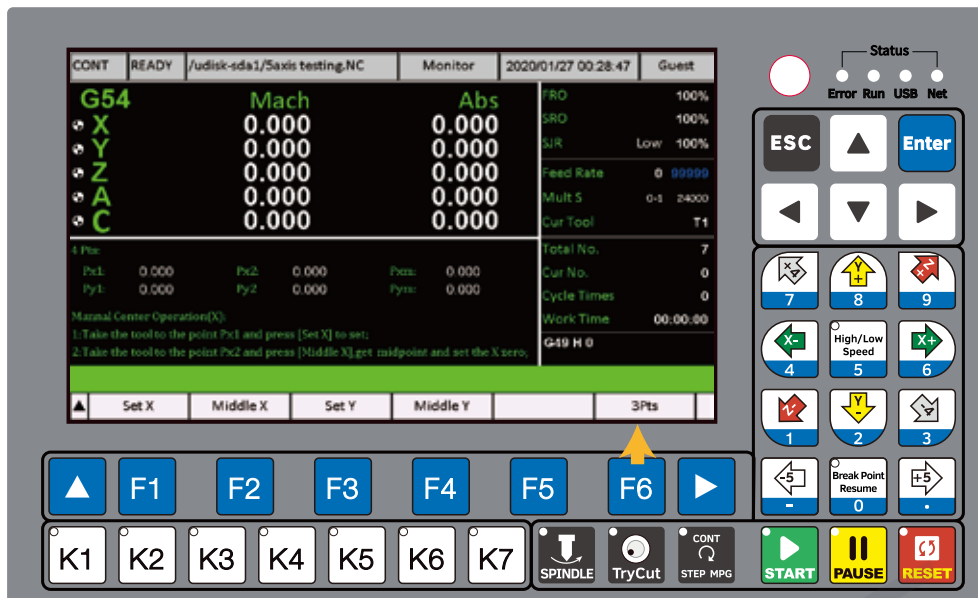

Figure 5-92 Press F6 Go to Middle Arc Page



Figure 5-93 Middle Arc Page

Here we also take an example to introduce the function.

To find a middle point for an Arc, we need to set 3 points on the Arc. Lets say, the first point is $X = 50 / Y = 100$, the second point is $X = 100 / Y = 50$, the third point is $X = 50 / Y = 0$.

Step 1: Set the first Point Position: We move the machine to $X = 50 / Y = 100$:

CONT	READY	Saxis testing.NC	Monitor	2020/01/26 23:01:15	Guest
G54		Mach	Abs	FRO	100%
X	50.000	50.000	SRO	100%	
Y	100.000	100.000	SJR	Low 100%	
Z	0.000	0.000	Feed Rate	0 99999	
A	0.000	0.000	Mult S	0-1 24000	
C	0.000	0.000	Cur Tool	T1	
Arc 3 pts			Total No.	7	
First pts:	Second pts:	Third pts:	Center:	Cur No.	0
X: 0.000	0.000	0.000	0.000	Cycle Times	0
Y: 0.000	0.000	0.000	0.000	Work Time	00:00:00
1: Move to the first point and press [Set 1]; 2: Move to the second point and press [Set 2]; 3: Move to the third point and press [Middle], get center of arc and set it to zero;					
▲	Set 1	Set 2	Middle		4pts

Figure 5-94 X=50,Y=100

Step 2: Press “Set 1” Key (F1), then the first point Position is saved.

MPG	READY	23232.txt	IO	2000/12/22 05:13:49	Guest								
Stat	Port Name				Enable	Pin No.	Polarity						
●	X-axis servo alarm signal				x	NULL	N						
●	Y-axis servo alarm signal				x	NULL	N						
●	Z-axis servo alarm signal				x	NULL	N						
●	Spindle alarm signal				x	NULL	N						
●	5th-axis servo alarm signal				x	NULL	N						
●	negative X-axis hard limit signal				x	NULL	N						
●	negative Y-axis hard limit signal				x	NULL	N						
●	negative Z-axis hard limit signal				x	NULL	N						
●	negative 4th-axis hard limit signal				x	NULL	N						
●	negative 5th-axis hard limit signal				x	NULL	N						
●	positive X-axis hard limit signal				x	NULL	N						
●	positive Y-axis hard limit signal				x	NULL	N						
IN	IN01	IN02	IN03	IN04	IN05	IN06	IN07	IN08	IN09	IN10	IN11	IN12	IN13
	IN14	IN15	IN16	IN17	IN18	IN19	IN20	IN21	IN22	IN23	IN24		
MPG	X1	X10	X100	HX	HY	H2	HA	HB		-54			0
OUT	OUT01	OUT02	OUT03	OUT04	OUT05	OUT06	OUT07	OUT08	OUT09	OUT10	OUT11	OUT12	OUT13
	OUT14	OUT15	OUT16	OUT17	OUT18	OUT19	OUT20	OUT21					
▲	Out Open		Out Close		Change Polarity								

Figure 5-95 First point Position is saved

Step 3: Set the second Point Position: We move the machine to X = 100 / Y = 50:

CONT	READY	Saxis testing.NC	Monitor	2020/01/26 23:01:32	Guest
G54		Mach	Abs	FRO	100%
X	100.000	100.000	SRO	100%	
Y	50.000	50.000	SJR	Low 100%	
Z	0.000	0.000	Feed Rate	0 99999	
A	0.000	0.000	Mult S	0-1 24000	
C	0.000	0.000	Cur Tool	T1	
Arc 3 pts			Total No.	7	
First pts:	Second pts:	Third pts:	Center:	Cur No.	0
X: 50.000	0.000	0.000	0.000	Cycle Times	0
Y: 100.000	0.000	0.000	0.000	Work Time	00:00:00
1: Move to the first point and press [Set 1]; 2: Move to the second point and press [Set 2]; 3: Move to the third point and press [Middle], get center of arc and set it to zero;					
▲	Set 1	Set 2	Middle		4pts

Figure 5-96 X=100,Y=50

Step 4: Press “Set 2” Key (F2), then the second point Position is saved.

CONT	READY	Saxis testing.NC	Monitor	2020/01/27 00:23:55	Guest
G54		Mach	Abs	FRO	100%
X		100.000	100.000	SRO	100%
Y		50.000	50.000	SJR	Low 100%
Z		0.000	0.000	Feed Rate	0 99999
A		0.000	0.000	Mult S	0-1 24000
C		0.000	0.000	Cur Tool	T1
Arc 3 pts:				Total No.	7
	First pts:	Second pts:	Third pts:	Center:	Cur No.
	X: 50.000	100.000	0.000	0.000	0
	Y: 100.000	50.000	0.000	0.000	Cycle Times
	1: Move to the first point and press [Set 1];				0
	2: Move to the second point and press [Set 2];				Work Time
	3: Move to the third point and press [Middle], get center of arc and set it to zero;				00:00:00
				G49 H 0	
▲	Set 1	Set 2	Middle		4pts

Figure 5-97 The second point Position is saved

Step 5: Set the third Point Position: We move the machine to X = 50 / Y = 0 :

CONT	READY	Saxis testing.NC	Monitor	2020/01/26 23:01:47	Guest
G54		Mach	Abs	FRO	100%
X		50.000	50.000	SRO	100%
Y		0.000	0.000	SJR	Low 100%
Z		0.000	0.000	Feed Rate	0 99999
A		0.000	0.000	Mult S	0-1 24000
C		0.000	0.000	Cur Tool	T1
Arc 3 pts:				Total No.	7
	First pts:	Second pts:	Third pts:	Center:	Cur No.
	X: 50.000	100.000	0.000	0.000	0
	Y: 100.000	50.000	0.000	0.000	Cycle Times
	1: Move to the first point and press [Set 1];				0
	2: Move to the second point and press [Set 2];				Work Time
	3: Move to the third point and press [Middle], get center of arc and set it to zero;				00:00:00
				G49 H 0	
▲	Set 1	Set 2	Middle		4pts

Figure 5-98 X=50,Y=0

Step 6: Press “ Middle ” Key (F3), then the third point Position is saved. And The system calculate the Middle point from the 3 point position, and set this middle point position as the Zero in the workpiece coordinate (G54 - G59).

CONT	READY	Saxis testing.NC	Monitor	2020/01/26 23:01:54	Guest
G54		Mach	Abs	FRO	100%
X		50.000	0.000	SRO	100%
Y		0.000	-50.000	SJR	Low 100%
Z		0.000	0.000	Feed Rate	0 99999
A		0.000	0.000	Mult S	0-1 24000
C		0.000	0.000	Cur Tool	T1
Arc 3 pts:				Total No.	7
	First pts:	Second pts:	Third pts:	Center:	Cur No.
	X: 50.000	100.000	50.000	50.000	0
	Y: 100.000	50.000	0.000	50.000	Cycle Times
	1: Move to the first point and press [Set 1];				0
	2: Move to the second point and press [Set 2];				Work Time
	3: Move to the third point and press [Middle], get center of arc and set it to zero;				00:00:00
				G49 H 0	
▲	Set 1	Set 2	Middle		4pts

Figure 5-99 Find Middle for the Arc

Arc 3 pts:				
	First pts:	Second pts:	Third pts:	Center:
X:	50.000	100.000	50.000	50.000
Y:	100.000	50.000	0.000	50.000

First Pts:

X: The First Point Position in X axis in Mechanical Coordinate;

Y: The First Point Position in X axis in Mechanical Coordinate;

Second Pts:

X: The second point Position in X Axis in Mechanical Coordinate;

Y: The second point Position in Y Axis in Mechanical Coordinate;

Third Pts:

X: The Third point Position in X Axis in Mechanical Coordinate;

Y: The Third point Position in Y Axis in Mechanical Coordinate;

Center Pts:

X: The Center Points in X Axis in Mechanical Coordinate;

Y: The Center Points in X Axis in Mechanical Coordinate.

www.ddcnc.com

5.12 Work Record

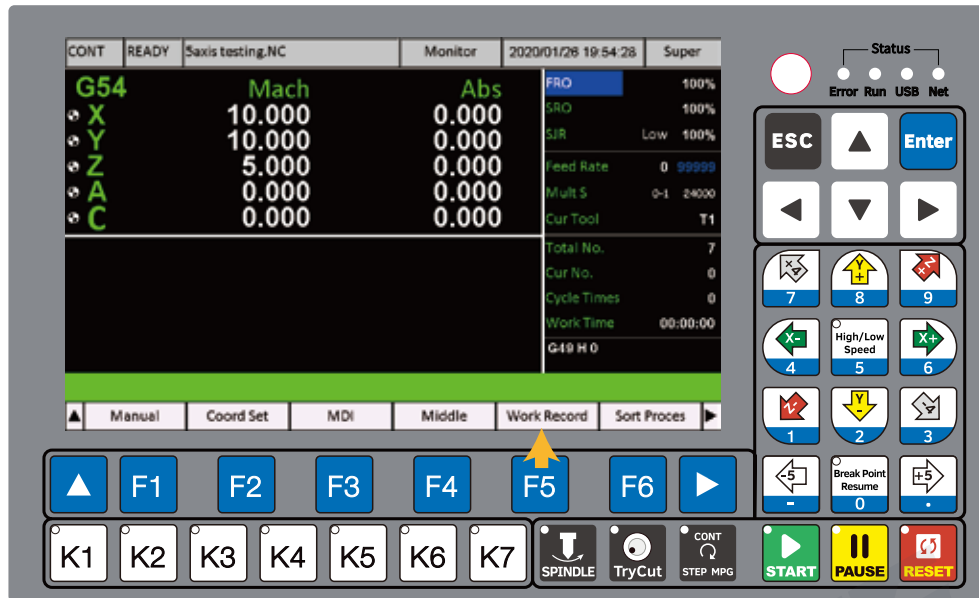

Figure 5-100 Press F5 key to "Work Record" Page

In the Work Record Page, we can check out the work record after the controller power on.

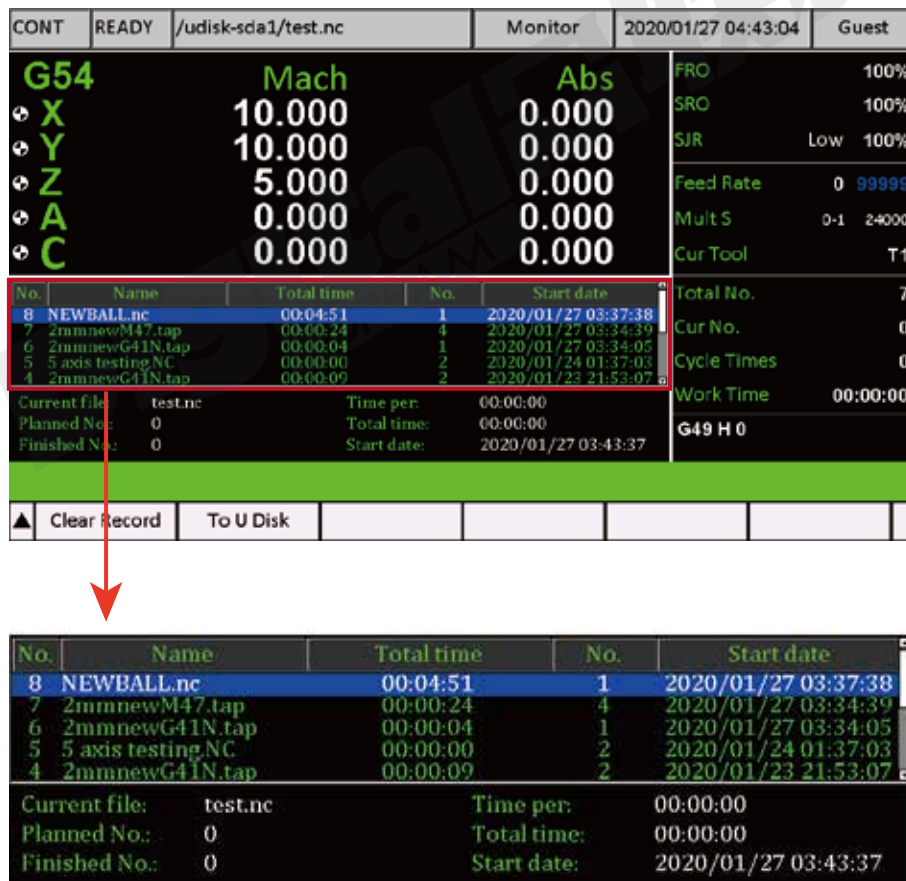

Figure 5-101 "Work Record" Page

No.: The Processed G-code file Number;

Name: The G-code file name;

Total Time: The according G-code file processing time;

No.: The processing times of the according G-code file;

Start date: The G-code file start processing time;

Current File: The current G-code file,if you press G-code file, system will process the current file.

Press F2, the system will export the working record to USB stick and named it as “ PROCESS_MSG.txt ”.

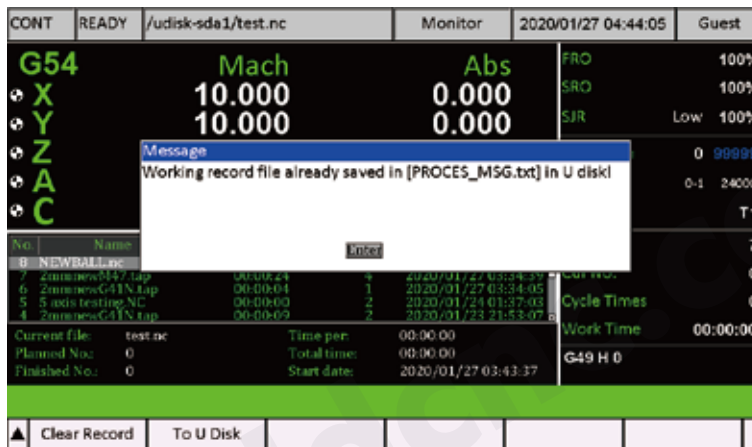

Figure 5-102 Save the record to U Disk

Press F1,The System clear all the record.



Figure 5-103 Clear the working record

5.13 Sort Process

“Sort Process” function is in reservation now.

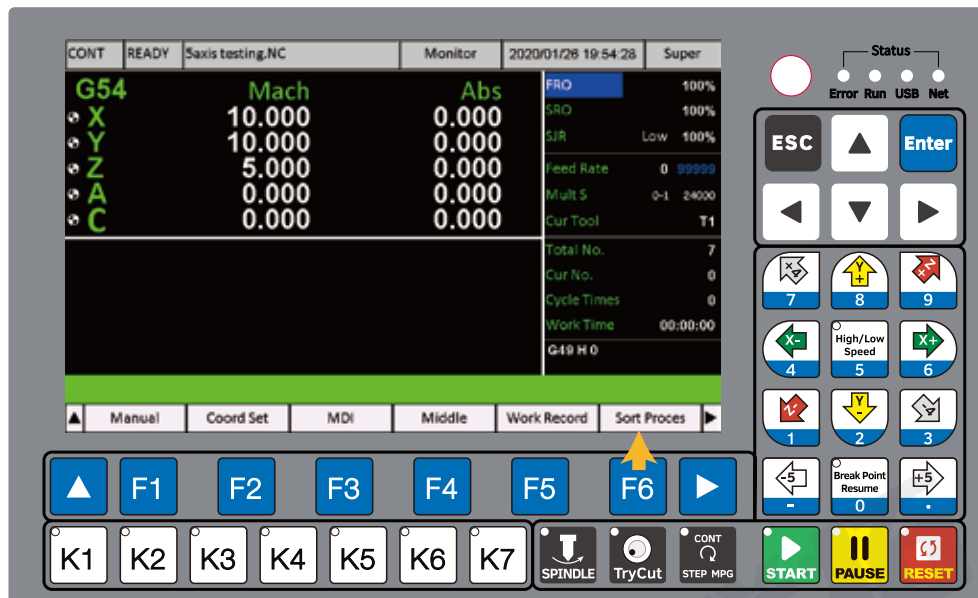

Figure 5-104 Press F6 key to “Sort Process” Page

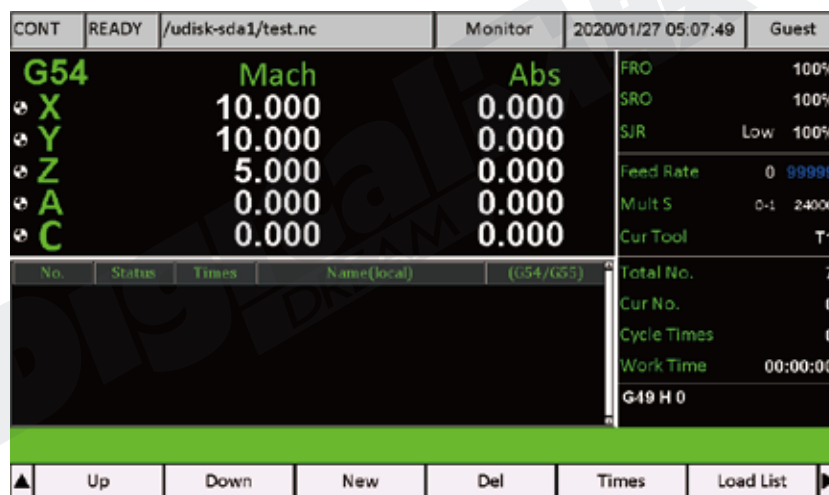

Figure 5-105 Press F6 key to “Sort Process” Page

In the Sort Process Page, we can organize, sort, and set times and sequence of different G-code files in our control system.

Press “New” Key (F3) to import some G-code file from the Local Disk. Please note that the files can only be imported from the Local Disk. If you have the files in USB-stick, please copy them into the local disk firstly.

CONT	READY	/udisk-sda1/test.nc	Program	2020/01/27 05:08:49	Guest
Local Disk(C)		Name	Size	Modify time	
U Disk(N)		2mmnewM47.tap	879 B	2020/01/27 13:05	
Net Disk(G)		ball1.nc	1.58 M	2020/01/27 13:05	
		2mmnewG41N.tap	80 B	2020/01/27 13:05	
		NEWBALL.nc	2.37 M	2020/01/27 13:05	
		2mmnew.tap	1.45 M	2020/01/27 13:05	
Cur Path:		/local	Free Space:	824.77 MB	
▲	Switch disks	Del	Rename	Copy To U Disk	New Edit ▶

Figure 5-106 Import the G-code files from the Local Disk

CONT	READY	/udisk-sda1/test.nc	Monitor	2020/01/27 05:09:14	Guest
G54		Mach	Abs	FRO	100%
⊕	X	10.000	0.000	SRO	100%
⊕	Y	10.000	0.000	SJR	Low 100%
⊕	Z	5.000	0.000	Feed Rate	0 99999
⊕	A	0.000	0.000	Mult S	0-1 24000
⊕	C	0.000	0.000	Cur Tool	T1
No.	Status	Times	Name(local)	(G54/G55)	Total No.
1	READY	0/1	/local/ball1.nc	G54	7
2	READY	0/1	/local/2mmnewM47.tap	G54	Cur No.
3	READY	0/1	/local/2mmnewG41N.tap	G54	0
4	READY	0/1	/local/NEWBALL.nc	G54	Cycle Times
5	READY	0/1	/local/2mmnew.tap	G54	0
					Work Time
					00:00:00
					G49 H 0
▲	Up	Down	New	Del	Times Load List ▶

Figure 5-107 The G-code files imported in

6 Program

In the main page, press F2 to Program Page.

In the program page, the users can browse the internal memory of the controller, and the USB Stick, or the Net Disk when the ethernet is built up.

In the Program Page, the users can Delete a file, Rename a file, Create a file, Copy and Paste a file;

In the Program Page, the users can edit a file with the virtual keyboard;

In the Program Page, the users can copy a file from USB-stick / Net Disk to Local, or Copy a file from Local to USB-stick / Net Disk.

In the Program Page, the users can simulate a G-code file, only to preview toolpath, without sending any pulse.

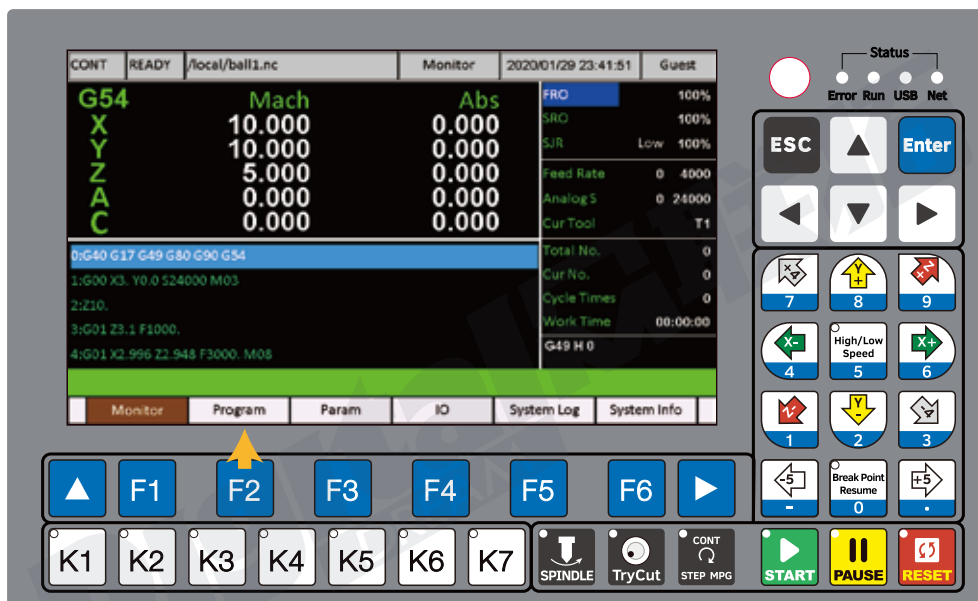

Figure 6-1 Press F2 To Program Page

In the first Program Page, press F1 (Switch Disks) , System will switch between the Local and USB Disk / Net Disk. Please note that, if Ethernet build up and controller can communicate the computer, then the system only can switch between the Local and Net Disk;

Press F2 (Del) , the System will delete the current file;

Press F3 (Rename) , we can rename the file by the panel keyboard or by external USB keyboard.

Press F4 (Copy To U Disk) , the system can copy the current file from Local to USB-Stick; if in the U Disk, this column will be " Copy To Local " , then can quickly copy file from USB-Stick to Local.

Press F5 (New) , the system will create a new ".nc" file;

Press F6 (Edit) , the system can open the current file, and on the right page, pop up a virtual keyboard to edit. The virtual keyboard usage, please refers to Chapter 5.1.10.

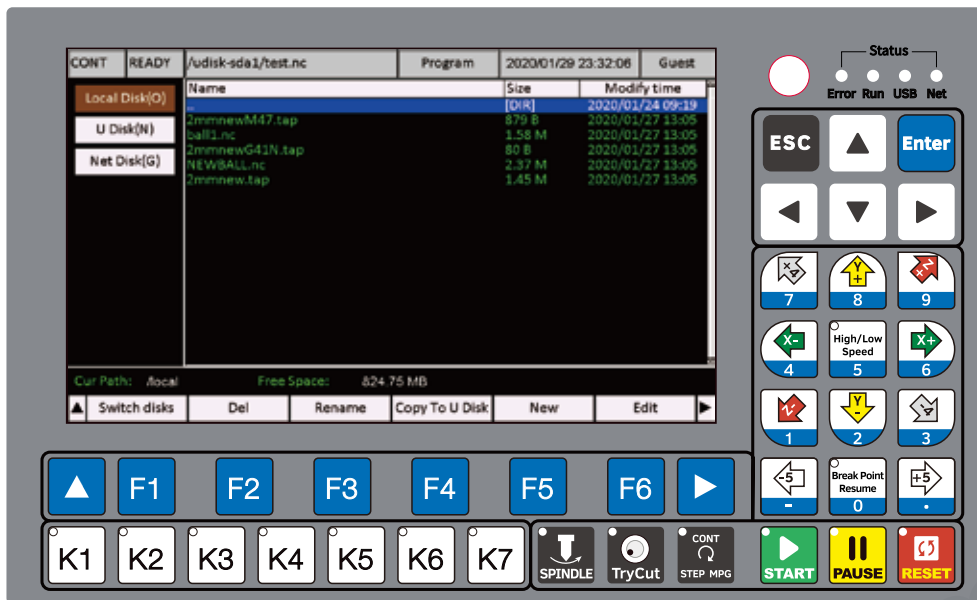

Figure 6-2 First Sub-Page of Program Page

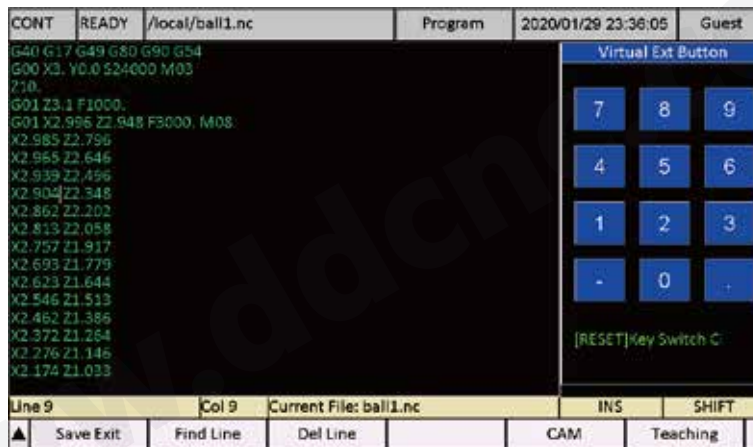



Figure 6-3 Edit a program by the virtual keyboard

Press  to the second sub-page of Program Page.

In the second Program Page, press F1 (Copy) , System copy the current file ;

Press F2 (Paste) , the System will Paste the current file;

Press F3 (Simulate) , the system will simulate the current file, just for users to preview the toolpath, the control system don't send any commands;

Press F4 (Load NC) , the system load the current file;

Press F5 (Clear Local) , the system will delete all the files or folders in the Local,the Local memory is empty.

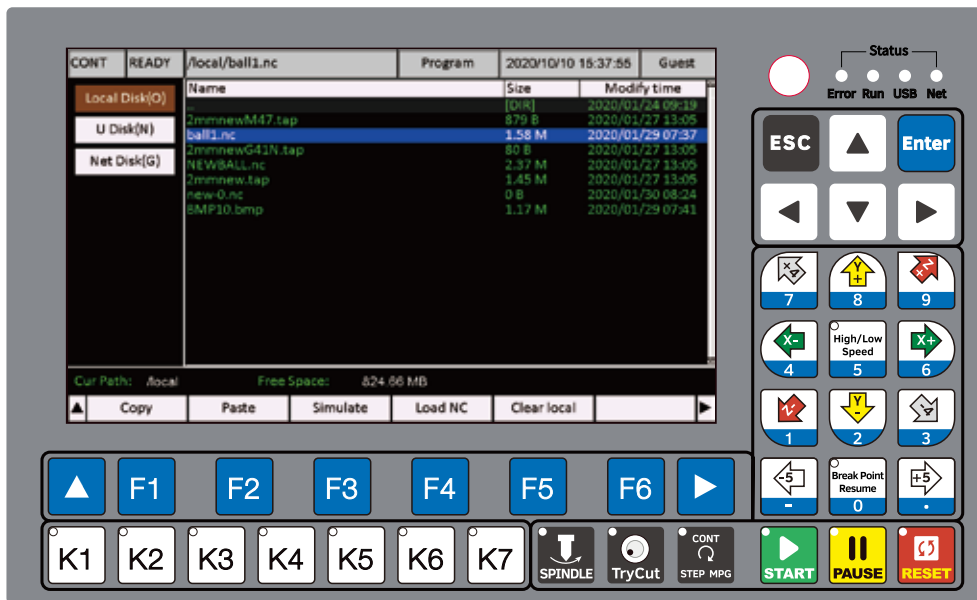

Figure 6-4 Second Sub-Page of Program Page

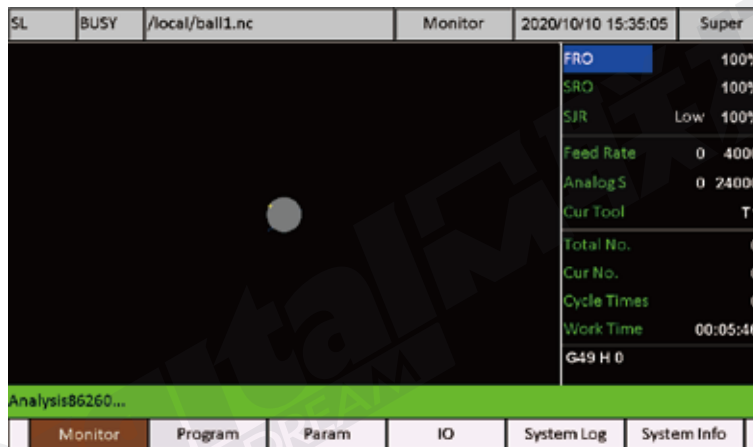

Figure 6-5 Preview the toolpath by Simulating a file

7 Parameters

In the main page, press F3 to Parameters Page.

All the parameters setting are in this page.

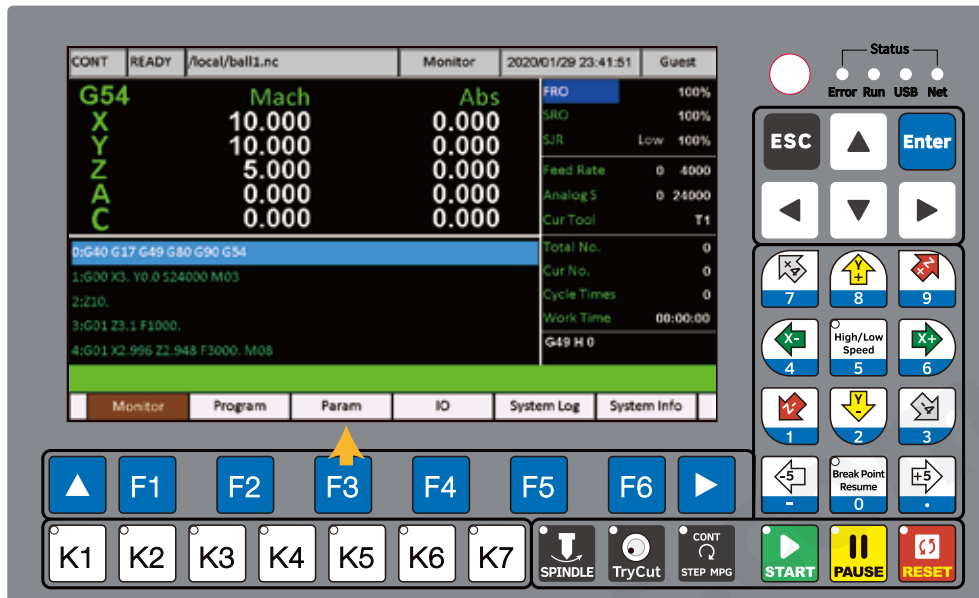

Figure 7-1 Press F3 to Parameters Page

7.1 Parameters List and Details

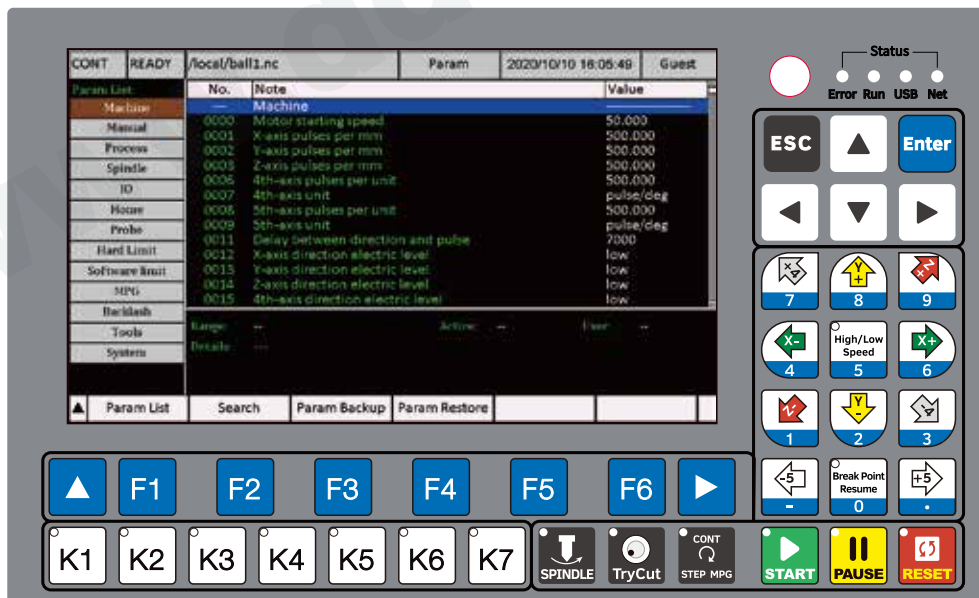







Figure 7-2 Parameters Page

In the Parameters Page, there are 13 kinds of parameters. The users can view the parameters one by one very easily by rotary button , up  or  down keys, and the left key  or right key  are for the kinds switching.

1) Machine (Totally 23 items)

No.	Parameter definition	Default value	Range and Unit	User
#0	Motor starting speed	50	1~999, mm/min	Operator
	If the given speed is higher than this speed, the motor will start to accelerate from this speed, or the motor will run at given speed.			
#1	X-axis pulses per mm	500	50~99999.000, pulse/mm	Operator
	When the axis is used to drive the spindle, the unit of this /parameter is the number of pulses per revolution.			
#2	Y-axis pulses per mm	500	50~99999.000, pulse/mm	Operator
	When the axis is used to drive the spindle, the unit of this /parameter is the number of pulses per revolution.			
#3	Z-axis pulses per mm	500	50~99999.000, pulse/mm	Operator
	When the axis is used to drive the spindle, the unit of this /parameter is the number of pulses per revolution.			
#6	4th-axis pulses per unit	500	50~99999.000, pulse/mm	Operator
	When the axis is used to drive the spindle, the unit of this /parameter is the number of pulses per revolution.			
#7	4th-axis unit	pulse/deg	pulse/deg or pulse/circle	Operator
	When this axis is used to drive the spindle motor,set the parameter to " pulse/deg ".			
#8	5th-axis pulses per unit	500	50~99999.000	Operator
	When this axis is used to drive the spindle motor, the unit of this parameter is the number of pulses per revolution.			
#9	4th-axis unit	pulse/deg	pulse/deg or pulse/circle	Operator
	When this axis is used to drive the spindle motor,set the parameter to " pulse/deg ".			
#11	Delay between direction and pulse	7000	0~9999.000, ns	Operator
	The default value is 7000, which is suitable for most drivers.			
#12	X-axis direction electric level	Low	High / Low	Operator
	This parameter is used to set the direction of X-axis.			
#13	Y-axis direction electric level	Low	High / Low	Operator
	This parameter is used to set the direction of Y-axis.			
#14	Z-axis direction electric level	Low	High / Low	Operator
	This parameter is used to set the direction of Z-axis.			
#15	4th-axis direction electric level	Low	High / Low	Operator
	This parameter is used to set the direction of 4th-axis.			
#16	5th-axis direction electric level	Low	High / Low	Operator
	This parameter is used to set the direction of 5th-axis.			
#17	X axis Pulse signal Electric Level	Low	High / Low	Operator
	If the X axis gradually offset during machining, reverse this parameter.			
#18	Y axis Pulse signal Electric Level	Low	High / Low	Operator
	If the Y axis gradually offset during machining, reverse this parameter.			
#19	Z axis Pulse signal Electric Level	Low	High / Low	Operator
	If the Z axis gradually offset during machining, reverse this parameter.			
#20	4th axis Pulse signal Electric Level	Low	High / Low	Operator
	If the 4th axis gradually offset during machining, reverse this parameter.			
#21	5th axis Pulse signal Electric Level	Low	High / Low	Operator
	If the 5th axis gradually offset during machining, reverse this parameter.			
#443	4th-axis name	A	X/Y/Z/A/B/C	Admin
	After restart the controller,the new setting is active.			
#444	5th-axis name	B	X/Y/Z/A/B/C	Admin
	After restart the controller,the new setting is active.			
#449	4th-axis Type	A	Linear/Rotation	Admin
	The parameter define the 4th axis is Linear axis or rotation axis.			
#450	5th-axis name	B	Linear/Rotation	Admin
	The parameter define the 5th axis is Linear axis or rotation axis.			

2) Manual (Totally 30 items)

No.	Parameter definition	Default value	Range and Unit	User
#35	X-axis max. speed in manual mode	20000	99~99999, mm / min	Operator
	The X-axis Max. speed in Manual Mode,even with the effect by SJR. When the X axis is configured to servo spindle, the unit is revolution / min. This Parameter must be bigger than #40.			
#36	Y-axis max. speed in manual mode	20000	99~99999, mm / min	Operator
	The Y-axis Max. speed in Manual Mode,even with the effect by SJR. When the Y axis is configured to servo spindle, the unit is revolution / min. This Parameter must be bigger than #41.			
#37	Z-axis max. speed in manual mode	8000	99~99999, mm / min	Operator
	The Z-axis Max. speed in Manual Mode,even with the effect by SJR. When the Z axis is configured to servo spindle, the unit is revolution / min. This Parameter must be bigger than #42.			
#38	4th-axis max. speed in manual mode	6000	99~99999, deg / min	Operator
	The 4th-axis Max. speed in Manual Mode,even with the effect by SJR. When the 4th-axis is configured to servo spindle, the unit is revolution / min. This Parameter must be bigger than #43.			
#39	5th-axis max. speed in manual mode	6000	99~99999, deg / min	Operator
	The 5th-axis Max. speed in Manual Mode,even with the effect by SJR. When the 4th-axis is configured to servo spindle, the unit is revolution / min. This Parameter must be bigger than #44.			
#40	X-axis manual control HIGH speed	10000	1000~99999, mm / min	Operator
	When the axis is configured to servo spindle, the unit of this /parameter is rpm.			
#41	Y-axis manual control HIGH speed	10000	1000~99999, mm / min	Operator
	When the axis is configured to servo spindle, the unit of this /parameter is rpm.			
#42	Z-axis manual control HIGH speed	5000	1000~99999, mm / min	Operator
	When the axis is configured to servo spindle, the unit of this /parameter is rpm.			
#43	4th-axis manual control HIGH speed	3000	1000~99999, deg / min	Operator
	When the axis is configured to servo spindle, the unit of this parameter is rpm.			
#44	5th-axis manual control HIGH speed	4000	1000~99999, deg / min	Operator
	When the axis is configured to servo spindle, the unit of this /parameter is rpm.			
#45	X-axis manual control LOW speed	1000	1000~99999, mm / min	Operator
	When the axis is configured to servo spindle, the unit of this parameter is rpm.			
#46	Y-axis manual control LOW speed	1000	1000 ~ 99999, mm / min	Operator
	When the axis is configured to servo spindle, the unit of this /parameter is rpm.			
#47	Z-axis manual control LOW speed	1000	1000 ~ 99999, mm / min	Operator
	When the axis is configured to servo spindle, the unit of this parameter is rpm.			
#48	4th-axis manual control LOW speed	1000	1000 ~ 99999, deg / min	Operator
	When the axis is configured to servo spindle, the unit of this parameter is rpm.			
#49	5th-axis manual control LOW speed	2000	1000 ~ 99999, deg / min	Operator
	When the axis is configured to servo spindle, the unit of this /parameter is rpm.			
#50	X-axis start acceleration in manual mode	1000	9 ~ 9999, mm / s ²	Operator
	When the axis is configured to servo spindle, the unit of this parameter is the number of revolution per s ² .			
#51	Y-axis start acceleration in manual mode	1000	9 ~ 9999, mm / s ²	Operator
	When the axis is configured to servo spindle, the unit of this parameter is the number of revolution per s ² .			
#52	Z-axis start acceleration in manual mode	1000	9 ~ 9999, mm / s ²	Operator
	When the axis is configured to servo spindle, the unit of this parameter is the number of revolution per s ² .			
#53	4th-axis start acceleration in manual mode	600	9 ~ 9999, mm / s ²	Operator
	When the axis is configured to servo spindle, the unit of this parameter is the number of revolution per s ² .			
#54	5th-axis start acceleration in manual mode	600	9 ~ 9999, mm / s ²	Operator
	When the axis is configured to servo spindle, the unit of this parameter is the number of revolution per s ² .			

No.	Parameter definition	Default value	Range and Unit	User
#55	X-axis stop acceleration in manual mode	1000	9~9999, mm / s ²	Operator
	When the axis is configured to servo spindle, the unit of this parameter is the number of revolution per s ² .			
#56	Y-axis stop acceleration in manual mode	1000	9~9999, mm / s ²	Operator
	When the axis is configured to servo spindle, the unit of this parameter is the number of revolution per s ² .			
#57	Z-axis stop acceleration in manual mode	1000	9~9999, mm / s ²	Operator
	When the axis is configured to servo spindle, the unit of this parameter is the number of revolution per s ² .			
#58	4th-axis stop acceleration in manual mode	600	9~9999, mm / s ²	Operator
	When the axis is configured to servo spindle, the unit of this parameter is the number of revolution per s ² .			
#59	5th-axis stop acceleration in manual mode	600	9~9999, mm / s ²	Operator
	When the axis is configured to servo spindle, the unit of this parameter is the number of revolution per s ² .			
#285	X-axis max. ACC G00	1000	9~9999, mm / s ²	Operator
	G00 command maximum acceleration.			
#286	Y-axis max. ACC G00	1000	9~9999, mm / s ²	Operator
	G00 command maximum acceleration.			
#287	Z-axis max. ACC G00	1000	9~9999, mm / s ²	Operator
	G00 command maximum acceleration.			
#288	4th-axis max. ACC G00	1000	9~9999, mm / s ²	Operator
	G00 command maximum acceleration.			
#289	5th-axis max. ACC G00	1000	9~9999, mm / s ²	Operator
	G00 command maximum acceleration.			

3) Process (Totally 26 items)

No.	Parameter definition	Default value	Range and Unit	User
#60	Speed Selection	Default	G Code / Default ;	Operator
	If #60 is set to Default, system will use the #61 speed value; If #60 set to G Code, system will use F command in the G-code file. This parameter can be quickly set by "Feed Rate" on the Main page.			
#61	default operation speed	3000	10~99999, mm/min	Operator
	If the G code file has no F command or #60 is set to Default, system will cite #61 as the feed rate. This parameter can be quickly set by "Feed Rate" on the Main page.			
#62	G01 ACC	500	9~9999, mm/s ²	Operator
	G01 \ G02 \ G03 acceleration. This parameter should be set according to the actual situation of the machine.			
#63	G00 speed	10000	99~99999, mm/min	Operator
	By the Parameter, we can set the speed of G0 Command.			
#64	Maximum speed	12000	99~99999, mm/min	Operator
	Maximum speed of the machine during machining.			
#65	Z-axis lifting protection speed	99999	99~99999, mm/min	Operator
	Z++ maximum speed. G00 is also valid.			
#66	Z-axis dropping protection speed	99999	99~99999, mm/min	Operator
	Z-- maximum speed. G00 is also valid.			
#67	X-axis protection speed	99999	99~99999, mm/min	Operator
	X-axis protection speed. G00 is also valid.			
#68	Y-axis protection speed	99999	99~99999, mm/min	Operator
	Y-axis protection speed. G00 is also valid.			
#69	Z axis safe height	5	0~999 mm	Operator
	When starting or restoring machining and go to work zero, the Z axis will move to Z axis safety height.			

No.	Parameter definition	Default value	Range and Unit	User
#70	Z-axis retraction dist. when paused	3	0~99 mm/min	Operator
	Z lift distance, when paused.			
#72	G0 command motion characteristics	Independent	Interpolation / Independent	Operator
	Interpolation: Synergistic movement of each axis; Independent: each axis independently moves at G0 speed.			
#73	Arc-interpolation algorithm	0	Hard alg / Soft alg	Operator
	Hard alg. : Interpolation accuracy is 0.5 pulses. Soft alg. : Accuracy is set by parameter #74.			
#74	Soft-arc algorithm linear error	0	0.001 ~ 0.1, mm	Operator
	The precision of the Soft-arc Algorithm.			
#75	Circular centrifugal acceleration	0	0~9999, mm/s ²	Operator
	Hard alg. : Interpolation accuracy is 0.5 pulses. Soft alg. : Accuracy is set by parameter #74.			
#76	Macro scan switch	0	closed / open	Operator
	Closed:do not scan file before processing; open: Scan files before processing; If the users set it to Open,system will assume a lot of time and calculation memory for scanning, please be careful to set the parameter.			
#77	Macro program file main program No.	0	0~9999	Operator
	In the Macro program,there will be a lot of the program number, so we need to assign a main program number.			
#90	Action selection before starting	No Action	No action / To Safety Z	Operator
	Here we set the Z axis movement when starting or resuming the controller; Safety height set by Param #69.			
#91	Z-axis movement mode during pause	No Action	No action / Z Distance	Operator
	Here we set the Z axis movement when pause the controller; Z-axis lifting distance set by Param #70.			
#220	Go to home before processing?	No	Yes / No	Operator
	A processing cannot be started without Go Home			
#221	Ref speed of arc with radius 5mm	0	0~3600000; mm/min	Operator
	The reference Arc Radius is 5mm; Other Arc speed please refers to this speed; If #221=0,The arc speed is related to parameters #62 and #75.			
#222	4th-axis protection speed	0	99~99999; mm/min	Operator
	4th-axis protection speed. G00 is also valid.			
#223	5th-axis protection speed	0	99~99999, mm/min	Operator
	5th-axis protection speed. G00 is also valid.			
#224	G73/G83 drilling retraction	0	0~20, mm	Operator
	G73 G83 drilling hole retraction distance.			
#230	Execute action after Finished	No Action	No action/Ref Pos/Work Zero	Operator
	Add M30 at the end of the file. Ref Pos: Mach pos of No.122-126.			
#282	G00 ACC	2000	0~9999, mm/s ²	Operator
	Here we acceleration in G00 interpolation mode; If we set it to 0, G00 cite linear acceleration; If we set it other value except 0, each axis accleration is limited by " Axis max. ACC G00 " (#285 ~ #289).			

4) Spindle (Totally 9 items)

No.	Parameter definition	Default value	Range and Unit	User
#79	Spindle interface type	Analog	Analog/Plu&Dir/Multi-Speed	Operator
	3 kinds spindle interface mode,users can choose according to the usage.			
#80	Spindle mapping axis	4th Axis	X / Y / Z / 4th / 5th Axis	Operator
	When the Spindle interface type is Pul&Dir, this parameter decide which axis is the servo spindle axis; In the mode of Servo Spindle, all the related parameter Unit is adjusted to "Rotation" .			
#81	Spindle start delay	2	0~9; S	Operator
	Delay time after spindle start command (M03/M04) response.			
#82	Maximum spindle speed	24000	0~99999; rpm	Operator
	When the spindle is in Multi-Speed Spindle,this parameter and #88 decide the spindle output segment.			
#83	Ignore the S command	No	No / Yes	Operator
	Start or resume the controller, spindle speed adopts parameter #85; This parameter also can be quickly set in the Main page.			
#84	Stop spindle when program is paused?	Yes	No / Yes	Operator
	When controller paused, this parameter decide to stop the spindle or not.			
#85	Default spindle speed	24000	0~99999; rpm	Operator
	If there is no S command in the G-code file, or #82 is Yes, the spindle speed can adopt this value . This parameter can be quickly set on the Main page.			
#88	Multi-speed section count	8	2~8, S	Operator
	When the section is 2, please define the "Spindle section Speed" output 1 ; When the section is 3 or 4, please define the "Spindle section speed" output 1 and 2; When the section is bigger than 4,please define "Spindle section speed" output 1 and 2 and 3.			
#89	Spindle stop delay	0	0~9, S	Operator
	Delay time after spindle stop command (M05) response.			

5) IO (Totally 17 items)

No.	Parameter definition	Default value	Range and Unit	User
#92	Duration of M8/M9 commands	2	Analog/Plu&Dir/Multi-Speed	Operator
	Delay time after cooling command response.			
#94	Duration of M10/M11 commands	2	0~9, S	Operator
	Delay time after lubrication command response.			
#95	IO input filter time width	50	0~1000000, ms	Operator
	This parameter helps the users to filter the electrical interference,to avoid the noise.			
#96	Reset IO Configuration bit 01-16	65535	0~65535	Operator
	We use decimal system to set the value; For Example, If OUT01~ OUT16 assigned to 1, then when reset, the current output port closed.			
#97	Reset IO Configuration bit 17-32	65535	0~65535	Operator
	We use decimal system to set the value; For Example, If OUT17~ OUT21 assigned to 1, then when reset, the current output port closed.			
#98	Alarm output status configuration bit 01-16	0	0~65535	Operator
	We use binary systemto to set the value; For example: 7=0111 / OUT0 OUT1 OUT2 output is Open after Alarm, or closed; By #264, the corresponding bit is configured as 1, then current output port enable status: 1: Enabled; 0: Disabled.			
#99	Alarm output status configuration bit 17-32	0	0~65535	Operator
	We use binary system to to set the value; For example: 7=0111 / OUT0 OUT1 OUT2 output is Open after Alarm, or closed; By #265, the corresponding bit is configured as 1, then current output port current status setting is : 1: Enabled; 0: Disabled.			

No.	Parameter definition	Default value	Range and Unit	User
#210	K1 key Function	1	0~2000	Operator
#211	K2 key Function	1	0~2000	Operator
#212	K3 key Function	1	0~2000	Operator
#213	K4 key Function	1	0~2000	Operator
#214	K5 key Function	1	0~2000	Operator
#215	K6 key Function	1	0~2000	Operator
#216	K7 key Function	1	0~2000	Operator
#217	K8 key Function	1	0~2000	Operator
	Note for K1 - K8: 0=run macro file " key-1.nc" ; 1-32=Close or Open OUT1-OUT32; >1000=define as Function shortcuts key, please contact factory fro details information for the details.			
#264	Alarm output enable configuration bit 01-16	0	0~65535	Operator
	We use binary system to set the value; For Example, If OUT1~ OUT16 assigned to 1, then when Alarm, the current enable status 1: Enable; 0: Disable; Before set parameter #98, we need to enable the corresponding bit first.			
#265	Alarm output enable configuration bit 17-32	0	0~65535	Operator
	We use binary system to set the value; For Example, If OUT17~ OUT21 assigned to 1, then when Alarm, the current enable status 1: Enable; 0: Disable; Before set parameter #99, we need to enable the corresponding bit first.			

6) HOME (Totally 28 items)

No.	Parameter definition	Default value	Range and Unit	User
#100	Home mode	Switch	Switch/Absolute	Admin
	Switch: Wire with Mechanical/Proximity limited Switch; Absolute: Bus absolute servo mode.			
#101	Servo absolute laps at the X-axis Home	0	-99999~99999; r	Operator
	The revolution when servo is in null position, floating type with direction.			
#102	Servo absolute laps at the Y-axis Home	0	-99999~99999; r	Operator
	The revolution when servo is in null position, floating type with direction.			
#103	Servo absolute laps at the Z-axis Home	0	-99999~99999; r	Operator
	The revolution when servo is in null position, floating type with direction.			
#104	Servo absolute laps at the 4th-axis Home	0	-99999~99999; r	Operator
	The revolution when servo is in null position, floating type with direction.			
#105	Servo absolute laps at the 5th-axis Home	0	-99999~99999; r	Operator
	The revolution when servo is in null position, floating type with direction.			
#106	Homing cycle count	3	1 ~ 5	Operator
	The repeated Home detection times.			
#107	X-axis homing speed	500	99~99999, mm/min	Operator
	The Initial speed When the X-axis go home.			
#108	Y-axis homing speed	500	99~99999, mm/min	Operator
	The Initial speed When the Y-axis go home.			
#109	Z-axis homing speed	500	99~99999, mm/min	Operator
	The Initial speed When the Z-axis go home.			
#110	4th-axis homing speed	500	99~99999, mm/min	Operator
	The Initial speed When the 4th-axis go home.			
#111	5th-axis homing speed	500	99~99999, mm/min	Operator
	The Initial speed When the 5th-axis go home.			

No.	Parameter definition	Default value	Range and Unit	User
#112	X-axis homing direction	Negative	Negative / Positive	Operator
	The initial moving direction When Home X-axis.			
#113	Y-axis homing direction	Negative	Negative / Positive	Operator
	The initial moving direction When Home Y-axis.			
#114	Z-axis homing direction	Positive	Negative / Positive	Operator
	The initial moving direction When Home Z-axis.			
#115	4th-axis homing direction	Negative	Negative / Positive	Operator
	The initial moving direction When Home 4th-axis.			
#116	5th-axis homing direction	Negative	Negative / Positive	Operator
	The initial moving direction When Home 5th-axis.			
#122	Mach position after X go home	5	-999~999; mm	Operator
	When X axis homing finished,system will excute G28 command, X axis move to the position this parameter set;			
#123	Mach position after Y go home	5	-999~999; mm	Operator
	When X axis homing finished,system will excute G28 command, Y axis move to the position this parameter set;			
#124	Mach position after Z go home	-5	-999~999; mm	Operator
	When X axis homing finished,system will excute G28 command, Z axis move to the position this parameter set;			
#125	Mach position after 4th go home	5	-999~999; mm	Operator
	When X axis homing finished,system will excute G28 command, 4th axis move to the position this parameter set;			
#126	Mach position after 5th go home	40	-999~999; mm	Operator
	When X axis homing finished,system will excute G28 command, 5th axis move to the position this parameter set;			
#127	Home after booting	Yes	Yes / No	Operator
	Yes: When power on the controller, system pop-up dialog box to ask Home System or not;			
#235	X-axis Mach zero offset	0	-999~999; mm	Operator
	We can reduce the error made by machine struction or any other factors by setting the offset for X axis.			
#236	Y-axis Mach zero offset	0	-999~999; mm	Operator
	We can reduce the error made by machine struction or any other factors by setting the offset for Y axis.			
#237	Z-axis Mach zero offset	0	-999~999; mm	Operator
	We can reduce the error made by machine struction or any other factors by setting the offset for Z axis.			
#238	4th-axis Mach zero offset	0	-999~999; mm	Operator
	We can reduce the error made by machine struction or any other factors by setting the offset for 4th axis.			
#239	5th-axis Mach zero offset	0	-999~999; mm	Operator
	We can reduce the error made by machine struction or any other factors by setting the offset for 5th axis.			

7) Probe (Totally 11 items)

No.	Parameter definition	Default value	Range and Unit	User
#128	Is the Floating tool set valid?	Yes	Yes/No	Operator
	Enable or Disable the Floating Probe			
#129	Floating tool set thickness	Yes	0 ~ 99; mm	Operator
	Before floating probe, we need to measure out the sensor's thickness and set the #129.			
#130	Is the fixed tool set valid?	Yes	Yes/No	Operator
	Enable or Disable the Fixed Probe.			
#131	Probing cycle count	5	1-5	Operator
	The probe times. When the user active the Probe, the system can probe 1 - 5 times as what the users set. At last system calculate an average value.			
#132	Initial speed of Probing	150	50 - 99999; rpm	Operator
	The initial down speed of the Z axis after starting the tool setting.			
#135	Fixed probe X mach position	10	-9999 ~ 9999; mm	Operator
	The initial Position of X axis before Probe in Mach coordinate			
#136	Fixed probe Y mach position	10	-9999 ~ 9999; mm	Operator
	The initial Position of Y axis before Probe in Mach coordinate			
#137	Fixed probe Z mach position	10	-9999 ~ 9999; mm	Operator
	The initial Position of Z axis before Probe in Mach coordinate			
#138	Fixed probe 4th mach position	10	-9999 ~ 9999; mm	Operator
	The initial Position of 4th axis before Probe in Mach coordinate			
#139	Fixed probe 5th mach position	10	-9999 ~ 9999; mm	Operator
	The initial Position of 5th axis before Probe in Mach coordinate			
#140	Retraction distance after the end of probe	10	0 - 999; mm	Operator
	This parameter is relative.			

8) Hard Limit (Totally 5 items)

No.	Parameter definition	Default value	Range and Unit	User
#150	Stop mode when X-axis hard limit trigger	Emergency	Deceleration / Emergency	Operator
#151	Stop mode when Y-axis hard limit trigger	Emergency	Deceleration / Emergency	Operator
#152	Stop mode when Z-axis hard limit trigger	Emergency	Deceleration / Emergency	Operator
#153	Stop mode when 4th-axis hard limit trigger	Emergency	Deceleration / Emergency	Operator
#154	Stop mode when 5th-axis hard limit trigger	Emergency	Deceleration / Emergency	Operator

9) Software limit (Totally 15 items)

No.	Parameter definition	Default value	Range and Unit	User
#155	Enable software limits	Disable	Disable / Enable	Admin
	Total control switch for soft limit function of all axis; If the users want to disable single axis soft limits, just set the soft limit value of negative direction bigger than the limit value of positive direction.			
#156	Stop mode when X-axis software limit trigger	Emergency	Deceleration / Emergency	Operator
#157	Stop mode when Y-axis software limit trigger	Emergency	Deceleration / Emergency	Operator
#158	Stop mode when Z-axis software limit trigger	Emergency	Deceleration / Emergency	Operator
#159	Stop mode when 4th-axis software limit trigger	Emergency	Deceleration / Emergency	Operator
#160	Stop mode when 5th-axis software limit trigger	Emergency	Deceleration / Emergency	Operator
#161	Negative X-axis software limit	-9999	-9999~9999; mm	Operator
#162	Negative Y-axis software limit	-9999	-9999~9999; mm	Operator
#163	Negative Z-axis software limit	-9999	-9999~9999; mm	Operator
#164	Negative 4th-axis software limit	-9999	-9999~9999; mm	Operator
#165	Negative 5th-axis software limit	-9999	-9999~9999; mm	Operator
#166	Positive X-axis soft limit	9999	-9999~9999; mm	Operator
#167	Positive Y-axis soft limit	9999	-9999~9999; mm	Operator
#168	Positive Z-axis soft limit	9999	-9999~9999; mm	Operator
#169	Positive 4th-axis soft limit	9999	-9999~9999; mm	Operator
#170	Positive 5th-axis soft limit	9999	-9999~9999; mm	Operator

10) MPG (Totally 15 items)

No.	Parameter definition	Default value	Range and Unit	User
#171	Enable MPG Precision Control Mode	Disable	Enable / Disable	Operator
	If #171 = Enable, the system will store the pulses the wheels generated and send every single one out, so sometimes when the user stopped turning the wheel but machine axis will still move. This can lead to a crash; If #171 = Disable, when the user stopped turning the wheel the machine axis just immediately decelerate and stop.			
#172	MPG precision	0.004	0.001~0.01	Operator
	When the handwheel rate is X1, the distance one step of the wheel can move;			
#173	Enable ESTOP signal on MPG	Disable	Enable / Disable	Operator
	Enable or disable the reset function of the MPG.			
#174	Electric level of ESTOP on MPG	Low	Low / High	Operator
	Please set this parameter according to the actual MPG status.			
#175	MPG handwheel direction	Positive	Positive/ Negative	Operator
#176	Handwheel X1 speed	50	50~99999	Operator
	When the MPG speed Mode is on X1, the axis moving speed;			
#177	Handwheel X10 speed	50	50~99999	Operator
	When the MPG speed Mode is on X10, the axis moving speed;			
#178	Handwheel X100 speed	50	50~99999	Operator
	When the MPG speed Mode is on X100, the axis moving speed;			
#179	Handwheel stop adjustment increment value	0.05	0.001~0.5	Operator
	In handwheel guiding mode, stop turning the wheel, the deceleration adjustable increment value.			
#180	Handwheel change adjustment increment value	0.01	0.001~0.5	Operator
	In handwheel guiding mode, the deceleration or acceleration adjustable increment value when turning the wheel.			
#181	X-axis hand wheel manual Acc	50	9~9999; mm/s ²	Operator
#182	Y-axis hand wheel manual Acc	50	9~9999; mm/s ²	Operator
#183	Z-axis hand wheel manual Acc	50	9~9999; mm/s ²	Operator
#184	4th-axis hand wheel manual Acc	50	9~9999; mm/s ²	Operator
#185	5th-axis hand wheel manual Acc	50	9~9999; mm/s ²	Operator
	In MPG mode, the start or stop acceleration of each axis.			

11) Backlash (Totally 15 items)

No.	Parameter definition	Default value	Range and Unit	User
#190	Enable X-axis reverse direction backlash	Disable	Disable / Enable	Operator
	When X axis reverse direction backlash enabled, if X axis change the direction, the system will compensate the backlash distance (#195) automatically.			
#191	Enable Y-axis backlash	Disable	Disable / Enable	Operator
	When Y axis reverse direction backlash enabled, if X axis change the direction, the system will compensate the backlash distance (#196) automatically.			
#192	Enable Z-axis backlash	Disable	Disable / Enable	Operator
	When Z axis reverse direction backlash enabled, if X axis change the direction, the system will compensate the backlash distance (#197) automatically.			
#193	Enable 4th-axis backlash	Disable	Disable / Enable	Operator
	When 4th axis reverse direction backlash enabled, if X axis change the direction, the system will compensate the backlash distance (#198) automatically.			
#194	Enable 5th-axis backlash	Disable	Disable / Enable	Operator
	When 5th axis reverse direction backlash enabled, if X axis change the direction, the system will compensate the backlash distance (#199) automatically.			
#195	X-axis backlash distance	0	0~9.999; mm	Operator
#196	Y-axis backlash distance	0	0~9.999; mm	Operator
#197	Z-axis backlash distance	0	0~9.999; mm	Operator
#198	4th-axis backlash distance	0	0~9.999; mm	Operator
#199	5th-axis backlash distance	0	0~9.999; mm	Operator
#200	Backlash speed	0	0~99999; mm/min	Operator
	If the current speed is less than parameter #0, then the Backlash speed is #0 parameter.			
#400	H01 tool length offset	0	-999.999~999.999; mm	Operator
	When the tool length compensation number is 1 (H1), the compensation value; G43\G44 H01.			
#401	H02 tool length offset	0	-999.999~999.999; mm	Operator
	When the tool length compensation number is 2 (H2), the compensation value; G43\G44 H02.			
#402	H03 tool length offset	0	-999.999~999.999; mm	Operator
	When the tool length compensation number is 3 (H3), the compensation value; G43\G44 H03.			
#403	H04 tool length offset	0	-999.999~999.999; mm	Operator
	When the tool length compensation number is 4 (H4), the compensation value; G43\G44 H04.			
#404	H05 tool length offset	0	-999.999~999.999; mm	Operator
	When the tool length compensation number is 5 (H5), the compensation value; G43\G44 H05.			
#405	H06 tool length offset	0	-999.999~999.999; mm	Operator
	When the tool length compensation number is 6 (H6), the compensation value; G43\G44 H06.			
#406	H07 tool length offset	0	-999.999~999.999; mm	Operator
	When the tool length compensation number is 7 (H7), the compensation value; G43\G44 H07.			
#407	H08 tool length offset	0	-999.999~999.999; mm	Operator
	When the tool length compensation number is 8 (H8), the compensation value; G43\G44 H08.			
#408	H09 tool length offset	0	-999.999~999.999; mm	Operator
	When the tool length compensation number is 9 (H9), the compensation value; G43\G44 H09.			
#409	H10 tool length offset	0	-999.999~999.999; mm	Operator
	When the tool length compensation number is 10 (H10), the compensation value; G43\G44 H10.			
#410	H11 tool length offset	0	-999.999~999.999; mm	Operator
	When the tool length compensation number is 11 (H11), the compensation value; G43\G44 H11.			
#411	H12 tool length offset	0	-999.999~999.999; mm	Operator
	When the tool length compensation number is 12 (H12), the compensation value; G43\G44 H012.			

No.	Parameter definition	Default value	Range and Unit	User
#412	H13 tool length offset	0	-999.999~999.999; mm	Operator
	When the tool length compensation number is 13 (H13), the compensation value; G43\G44 H013.			
#413	H14 tool length offset	0	-999.999~999.999; mm	Operator
	When the tool length compensation number is 14 (H14), the compensation value; G43\G44 H014.			
#414	H15 tool length offset	0	-999.999~999.999; mm	Operator
	When the tool length compensation number is 15 (H15), the compensation value; G43\G44 H015.			
#415	H16 tool length offset	0	-999.999~999.999; mm	Operator
	When the tool length compensation number is 16 (H16), the compensation value; G43\G44 H016.			
#420	D01 tool Radius offset	0	-999.999~999.999; mm	Operator
	When the tool radius compensation number is 1 (D1), the compensation value; G41\G42 D01.			
#421	D02 tool Radius offset	0	-999.999~999.999; mm	Operator
	When the tool radius compensation number is 2 (D2), the compensation value; G41\G42 D02.			
#422	D03 tool Radius offset	0	-999.999~999.999; mm	Operator
	When the tool radius compensation number is 3 (D3), the compensation value; G41\G42 D03.			
#423	D04 tool Radius offset	0	-999.999~999.999; mm	Operator
	When the tool radius compensation number is 4 (D4), the compensation value; G41\G42 D04.			
#424	D05 tool Radius offset	0	-999.999~999.999; mm	Operator
	When the tool radius compensation number is 5 (D5), the compensation value; G41\G42 D05.			
#425	D06 tool Radius offset	0	-999.999~999.999; mm	Operator
	When the tool radius compensation number is 6 (D6), the compensation value; G41\G42 D06.			
#426	D07 tool Radius offset	0	-999.999~999.999; mm	Operator
	When the tool radius compensation number is 7 (D7), the compensation value; G41\G42 D07.			
#427	D08 tool Radius offset	0	-999.999~999.999; mm	Operator
	When the tool radius compensation number is 8 (D8), the compensation value; G41\G42 D08.			
#428	D09 tool Radius offset	0	-999.999~999.999; mm	Operator
	When the tool radius compensation number is 9 (D9), the compensation value; G41\G42 D09.			
#429	D10 tool Radius offset	0	-999.999~999.999; mm	Operator
	When the tool radius compensation number is 10 (D10), the compensation value; G41\G42 D10.			
#430	D11 tool Radius offset	0	-999.999~999.999; mm	Operator
	When the tool radius compensation number is 11 (D11), the compensation value; G41\G42 D011.			
#431	D11 tool Radius offset	0	-999.999~999.999; mm	Operator
	When the tool radius compensation number is 12 (D12), the compensation value; G41\G42 D012.			
#432	D11 tool Radius offset	0	-999.999~999.999; mm	Operator
	When the tool radius compensation number is 13 (D13), the compensation value; G41\G42 D013.			
#433	D11 tool Radius offset	0	-999.999~999.999; mm	Operator
	When the tool radius compensation number is 14 (D14), the compensation value; G41\G42 D014.			
#434	D11 tool Radius offset	0	-999.999~999.999; mm	Operator
	When the tool radius compensation number is 15 (D15), the compensation value; G41\G42 D015.			
#435	D11 tool Radius offset	0	-999.999~999.999; mm	Operator
	When the tool radius compensation number is 16 (D16), the compensation value; G41\G42 D016.			

No.	Parameter definition	Default value	Range and Unit	User
#800	Current tool No.	1	0~20	Operator
	When Tool number greater than 20 then it is the virtual tool number.			
#801	Total number of tools in Magazine	12	0~20	Operator
	The actual magazine capacity should be less than 20.			
#802	Tool magazine type	NULL	NULL/Multiple/Fixed row/Servo disc	Operator
	Tool Magazine type selection: Support multiple、 Follow row、 Fixed row、 Servo disc etc.			
#803	The virtual Tool function turned on?	No	No / Yes	Admin
	Enable Virtul tool. When the tool no. is over 20, the system execute as it is the virtual tool.			
#805	Automatic tool setting after tool change?	No	No / Yes	Operator
	Automatic Probe after tool change or not.			
#806	The highest position when chang Tool	0	-9999.999~9999.999; mm	Operator
	Z-axis Mach position			
#807	The lowest position when chang Tool	0	-9999.999~9999.999; mm	Operator
	Z-axis Mach position			
#808	X-axis tool change front Mach position	0	-9999.999~9999.999; mm	Operator
	X-axis machine position of deceleration position before entering the tool magazine.			
#809	Y-axis tool change front Mach position	0	-9999.999~9999.999; mm	Operator
	Y-axis machine position of deceleration position before entering the tool magazine.			
#810	Z-axis tool change front Mach position	0	-9999.999~9999.999; mm	Operator
	Z-axis machine position of deceleration position before entering the tool magazine.			
#811	Spindle move speed when changing the tool	100	9~99999; mm/min	Operator
	Spindle motor speed when changing the tool			
#812	Z-axis lifting speed when changing the tool	100	9~99999; mm/min	Operator
	Z-axis lifting speed when changing the tool.			
#813	Move the magazine speed horizontally	100	9~99999; mm/min	Operator
	The speed when move the magazine in horizontally.			
#814	Spindle lock output delay	100	9~99999; mm/min	Operator
	The delay time when changing the tool.			
#815	Go to the position before the tool change?	No	No / Yes	Operator
	If Yes, Z go to The highest position when chang Tool, and XYA returns to previous position before the tool change.			
#816	X mach pos when manually changing the tool	0	-9999.999~9999.999; mm	Operator
	X axis position in Mach coordinate when changing the tool manually.			
#817	Y mach pos when manually changing the tool	0	-9999.999~9999.999; mm	Operator
	Y axis position in Mach coordinate when changing the tool manually.			
#818	Z mach pos when manually changing the tool	0	-9999.999~9999.999; mm	Operator
	Z axis position in Mach coordinate when changing the tool manually.			
#819	Z axis downward movement speed	100	9~99999; mm/min	Operator
	"Speed when moving to position of Parameter #807.			
#820	Pushing start X mach pos	0	-9999.999~9999.999; mm	Operator
	The Starting Position of X axis in Mach coordinate when Pushing			
#821	Pushing start Y mach pos	0	-9999.999~9999.999; mm	Operator
	The Starting Position of Y axis in Mach coordinate when Pushing			
#822	Push Delay	1	0~600000; us	Operator
	The delay time before Pushing			

No.	Parameter definition	Default value	Range and Unit	User
#823	Pushing end X mach pos	0	-9999.999~9999.999; mm	Operator
	The Position of X axis when the Pushing finished.			
#824	Pushing end Y mach pos	0	-9999.999~9999.999; mm	Operator
	The Position of Y axis when the Pushing finished.			
#825	Pushing completed X mach pos	0	-9999.999~9999.999; mm	Operator
	The X axis position in Mach Coordinate when pushing finished each axis will back distance;			
#826	Pushing completed Y mach pos	0	-9999.999~9999.999; mm	Operator
	The Y axis position in Mach Coordinate when pushing finished each axis will back distance;			
#827	Push speed	0	9~9999; mm/min	Operator
	Each axis moving speed when Pushing.			
#830	T01 X mach pos	0	-9999.999~9999.999; mm	Operator
#831	T02 X mach pos	0	-9999.999~9999.999; mm	Operator
#832	T03 X mach pos	0	-9999.999~9999.999; mm	Operator
#833	T04 X mach pos	0	-9999.999~9999.999; mm	Operator
#834	T05 X mach pos	0	-9999.999~9999.999; mm	Operator
#835	T06 X mach pos	0	-9999.999~9999.999; mm	Operator
#836	T07 X mach pos	0	-9999.999~9999.999; mm	Operator
#837	T08 X mach pos	0	-9999.999~9999.999; mm	Operator
#838	T09 X mach pos	0	-9999.999~9999.999; mm	Operator
#839	T10 X mach pos	0	-9999.999~9999.999; mm	Operator
#840	T11 X mach pos	0	-9999.999~9999.999; mm	Operator
#841	T12 X mach pos	0	-9999.999~9999.999; mm	Operator
#842	T13 X mach pos	0	-9999.999~9999.999; mm	Operator
#843	T14 X mach pos	0	-9999.999~9999.999; mm	Operator
#844	T15 X mach pos	0	-9999.999~9999.999; mm	Operator
#845	T16 X mach pos	0	-9999.999~9999.999; mm	Operator

13) System (Totally 12 items)

No.	Parameter definition	Default value	Range and Unit	User
#240	Language	Eng	Eng/中文	Operator
#241	Enable buzzer feedback	Yes	Yes/No	Operator
#244	Enable realtime toolpath	No	Yes/No	Operator
	If enabled the realtime toolpath, the system operation can be slow down by the realtime processing.			
#245	Toolpath mode	Statue	Statue/Line/3D	Operator
	The 3D mode consumes minimum memory comparing the 3D or Statues Mode.			
#247	Interpolation period	0.005	0.001~0.010; s	Operator
	The smaller interpolation period, the higher the machining accuracy, but it will cost longer machining time.			
#248	LOGO display time	0.100	0.1~10; s	Operator
#261	X-axis rotation angle in 3D toolpath mode	0.000	-180~180; deg	Operator
#262	Y-axis rotation angle in 3D toolpath mode	0.000	-180~180; deg	Operator
#263	Z-axis rotation angle in 3D toolpath mode	0.000	-180~180; deg	Operator
#266	Serial 1 baud rate	B2400	B2400/B4800/B9600/B19200/B115200	Admin
#267	Serial 1 baud rate	B2400	B2400/B4800/B9600/B19200/B115200	Admin
#278	USB keyboard type	Closed	Closed/keyboard/Scanner	Admin
#279	Barcode file location	Local	Local/Udisk/NetDisk	Admin
#283	Barcode scanning processing	No	No/Yes/Test	Admin
	Please contact the factory to enable and design the Barcode scanning function.			
#284	Network boot mode	Close	Close/auto-IP/manu-IP	Admin
	In the current version, we only support the Set the IP address Manually.			

7.2 Search the Parameters by the Number

In our Parameters List, there are hundreds of parameters, it is very difficult for the users if there is no search function. By the search function, the users can search out the according parameters very fast.



Figure 7-3 Press F3 to Search Page

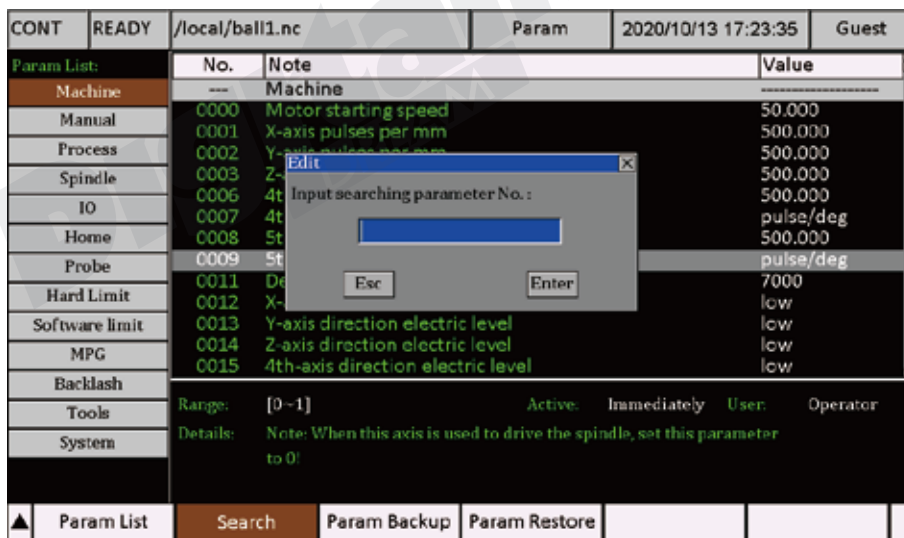

Figure 7-4 Press "Search" dialog box pop up

CONT	READY	/local/ball1.nc	Param	2020/10/13 17:23:42	Guest
Param List:					
		No.	Note	Value	
Machine		---	Machine	-----	
Manual		0000	Motor starting speed	50.000	
		0001	X-axis pulses per mm	500.000	
Process		0002	Y-axis pulses per mm	500.000	
Spindle		0003	Z-axis pulses per mm	500.000	
		0006	4th-axis pulses per mm	500.000	
IO		0007	4th-axis direction electric level	pulse/deg	
Home		0008	5th-axis direction electric level	500.000	
		0009	5th-axis direction electric level	pulse/deg	
Probe		0011	De	7000	
Hard Limit		0012	X-	low	
Software limit		0013	Y-axis direction electric level	low	
MPG		0014	Z-axis direction electric level	low	
		0015	4th-axis direction electric level	low	
Backlash					
Tools		Range:	[0-1]	Active:	Immediately
System		Details:	Note: When this axis is used to drive the spindle, set this parameter to 0!	User:	Operator
<div style="border: 1px solid black; padding: 5px; width: fit-content; margin: 10px auto;"> <input type="text" value="285"/> Esc Enter </div>					
▲	Param List	Search	Param Backup	Param Restore	

Figure 7-5 We write in Parameter Number and Press Enter

CONT	READY	/local/ball1.nc	Param	2020/10/13 17:23:48	Guest
Param List:					
		No.	Note	Value	
Machine		0047	Z-axis manual control LOW speed	1000.000	
		0048	4th-axis manual control LOW speed	1000.000	
Manual		0049	5th-axis manual control LOW speed	2000.000	
Process		0050	X-axis start acceleration in manual mode	1000.000	
Spindle		0051	Y-axis start acceleration in manual mode	1000.000	
		0052	Z-axis start acceleration in manual mode	1000.000	
IO		0053	4th-axis start acceleration in manual mode	600.000	
Home		0054	5th-axis start acceleration in manual mode	600.000	
Probe		0055	X-axis stop acceleration in manual mode	1000.000	
Hard Limit		0056	Y-axis stop acceleration in manual mode	1000.000	
Software limit		0057	Z-axis stop acceleration in manual mode	1000.000	
MPG		0058	4th-axis stop acceleration in manual mode	600.000	
		0059	5th-axis stop acceleration in manual mode	600.000	
		0285	X-axis max. ACC G00	1000.000	
Backlash					
Tools		Range:	[9.000-9999.000] mm/s ²	Active:	Immediately
System		Details:	G00 command maximum acceleration.	User:	Operator
▲	Param List	Search	Param Backup	Param Restore	

Figure 7-6 Now the according parameters searched out

7.3 Parameter Setting Backup

As the users spend time and energy to configure all the parameters, and want to save all the data, here in DDCS-Expert, we supply One-Key Backup function, convenient and easily.

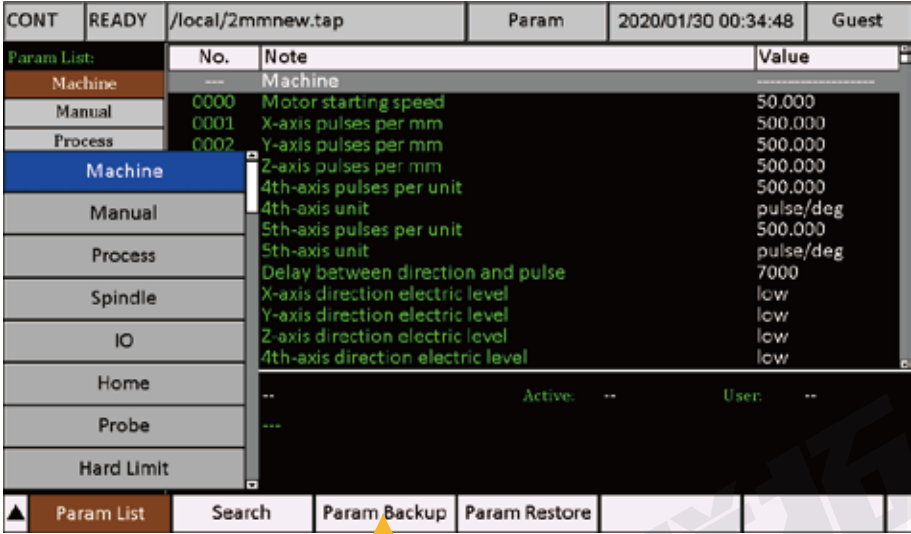

Figure 7-7 Press F3 to Backup the parameters

Please note here, that the system will backup the parameters information in a setting file to the USB-Stick, so we must insert a USB-stick on the controller before the action.

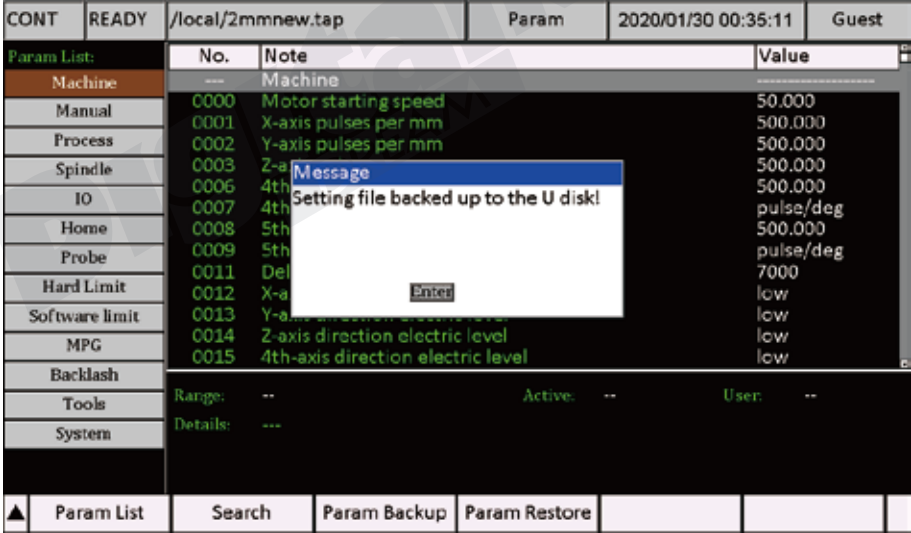

Figure 7-8 Parameters back up successfully

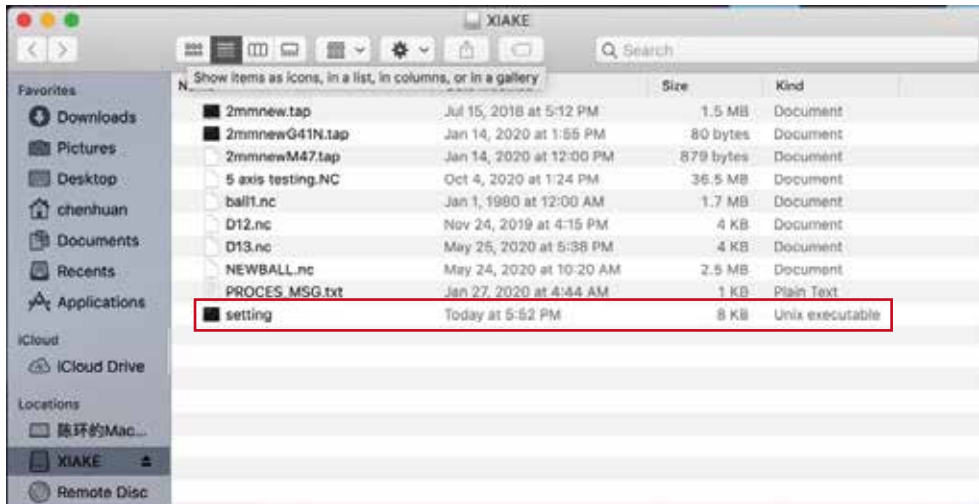

Figure 7-9 Parameters back up in the Setting file

7.4 Parameters Restore

The users can restore the parameters from the USB-stick. Here as we already had the setting file, we can just copy the setting file in the root direction of the USB-stick as the Figure 7-9, and insert it to controller.

We press F4 and turn knob to “Restore from U”, then a dialog box pop up to ask the password of admin or higher user. Input the correct password, and Enter, the system start to restore the parameters, when it finished the system can pop up a dialog box to show it is done.

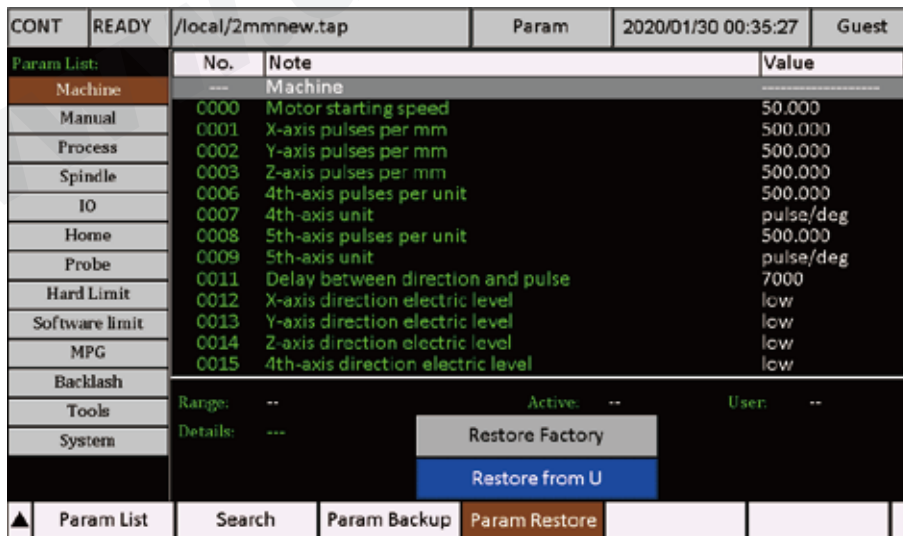

Figure 7-10 Parameters Restore from USB-Stick

CONT	READY	/local/ball1.nc	Param	2020/10/13 19:58:49	Super
Param List:					
		No.	Note	Value	
Machine		---	Machine	-----	
Manual		0000	Motor starting speed	50.000	
Process		0001	X-axis pulses per mm	500.000	
		0002	Y-axis pulses per mm	500.000	
Spindle		0003	Z-axis	500.000	
		0006	4th-a	500.000	
IO		0007	4th-a	pulse/deg	
Home		0008	5th-a	500.000	
Probe		0009	5th-a	pulse/deg	
Hard Limit		0011	Delay	7000	
		0012	X-axis	low	
Software limit		0013	Y-axis	low	
		0014	Z-axis direction electric level	low	
MFG		0015	4th-axis direction electric level	low	
Backlash					
Tools		Range:	[1.000-999.000] mm/min	Active:	Immediately
System		Detail:	If the given speed is higher than this speed, the motor will start to acc from this speed, otherwise the motor will run at the given speed. Effective range:[1-999]		
		▲ Param List	Search	Param Backup	Param Restore

Figure 7-11 Parameters Restore Successful from USB-Stick

Digital Dream 拓联科技

8 System Info

In the main page, press F6 to System Info Page.

In the Page, the users can:

- 1) Registration: The users can set a system working time;
- 2) Set the password for Operator, for Admin, and for Super Admin;
- 3) Can update the system software from the USB-stick;
- 4) Set the system date and time;
- 5) Set the IP address.

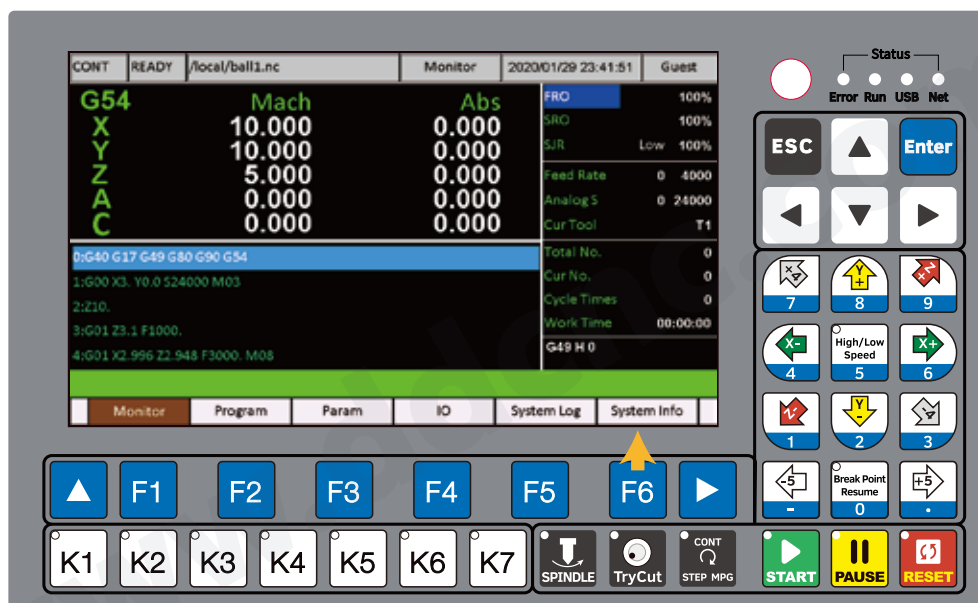

Figure 8-1 Press F6 to System Info Page

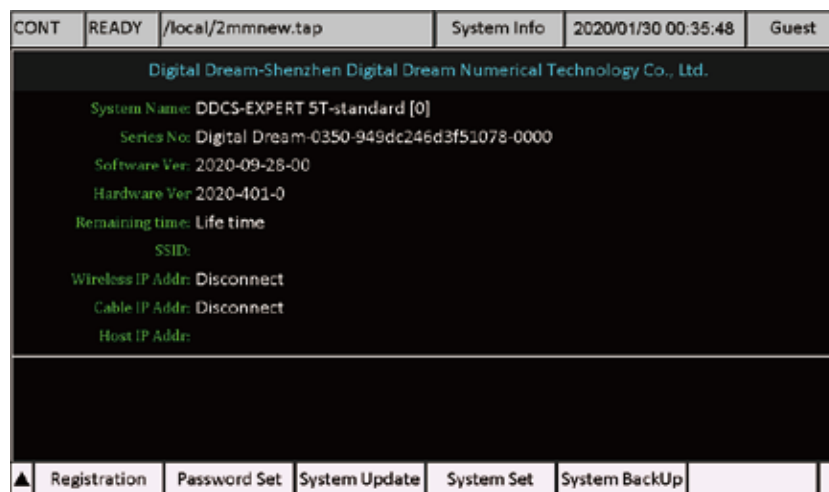

Figure 8-2 System Info Page

8.1 Registration

For the customers who want to control the controller working time, we supply a working time setting software “DDCS-Expert Key Generator”, please visit our website :

www.ddcnc.com

or our Facebook Forum:

https://www.facebook.com/groups/1724999967517167/?ref=group_header

to find the software and download it.

Now your zip program can recognise the file as a compressed file and you can decompress it as the Figure 8-3.

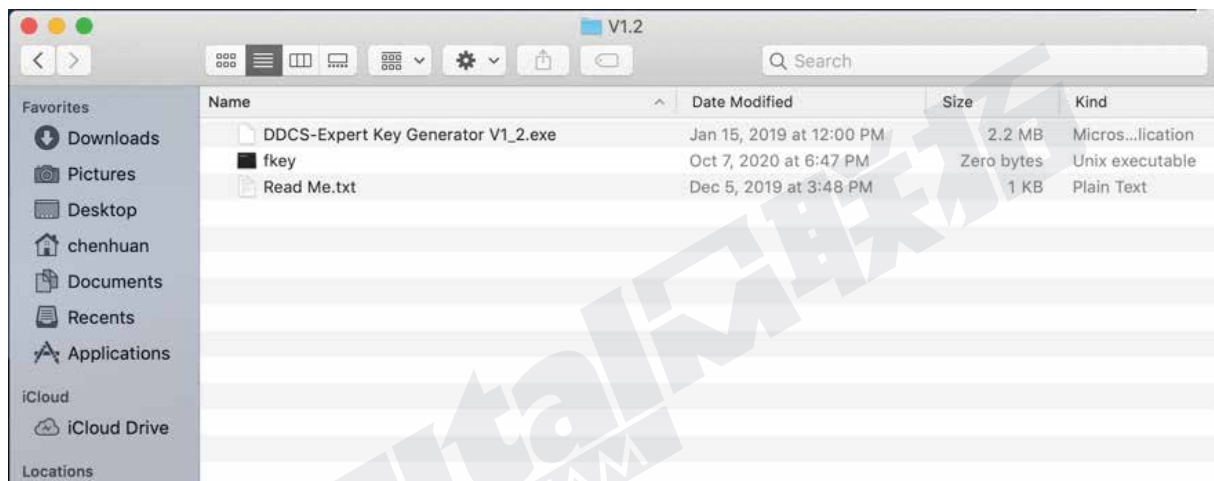

Figure 8-3 DDCS-Expert Key Generator Software folder

Double click the “DDCS-Expert key Generator V1_2.exe”, there will be a windows as Figure 8-3 pop on.

1) Series No: Each controller will have a unique series Number, we can input the number to the Series No. in Generator ; It only allow 6 charactors, so only write in “Digita” .

2) Time Setting: “-1” means no limited time; if you put any other numbers (Number range is 1-9999), the system will calculate the power on time, when the time reached to the limit, the controller don’ t work.

3) Super Admin Password, here only the users input right Super Admin Password, the setting can be active.Please note the default Super Admin Password is 888888.

4) When we finished input the numbers and Press button “ Generate ”, the software can update a new “fkey” in the same folder. The Users just copy the “fkey” file to root-directory of the USB-stick ,and insert it to the controller.

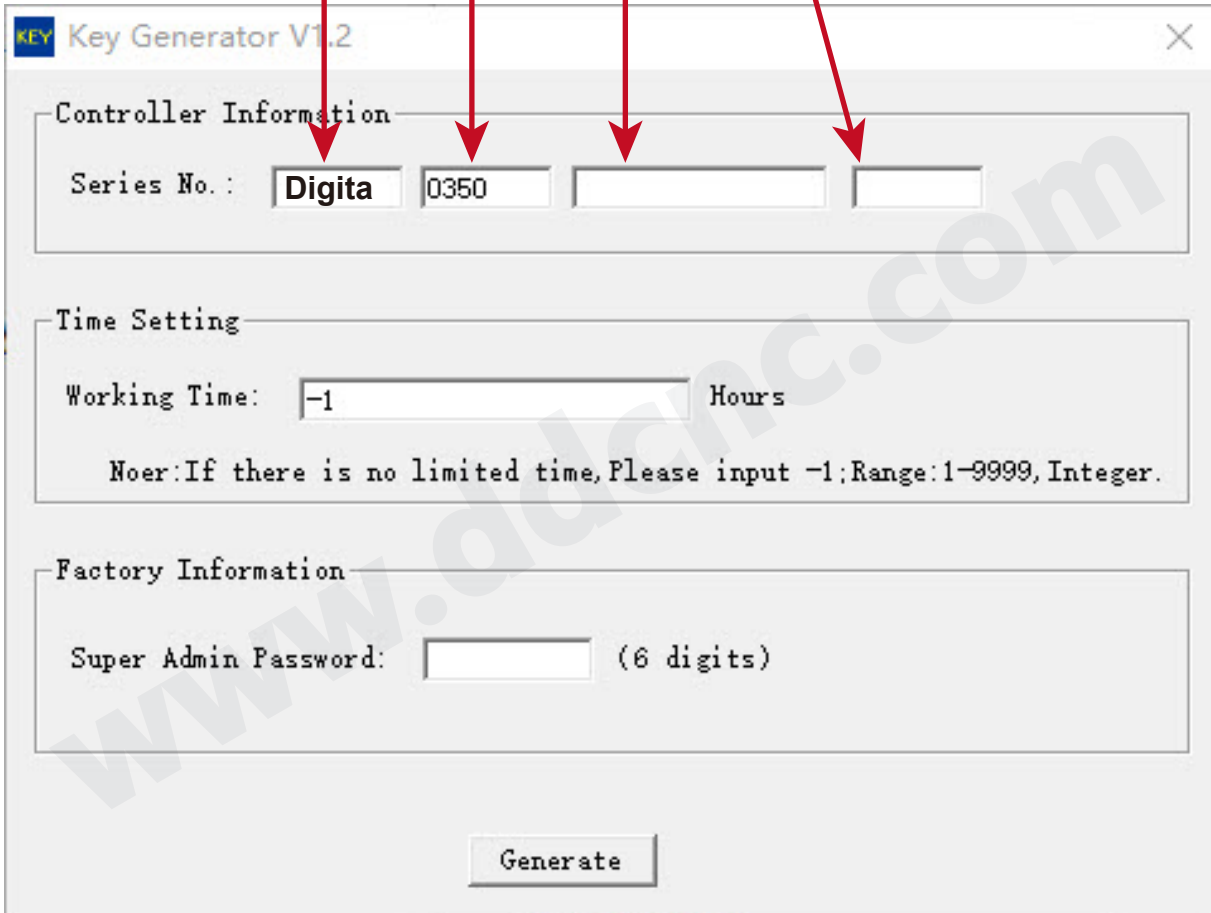
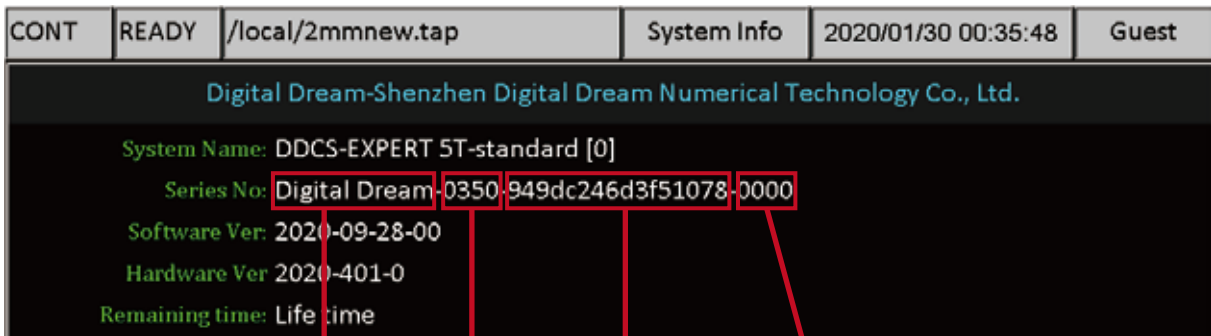

Figure 8-4 DDCS-Expert Key Generator Software

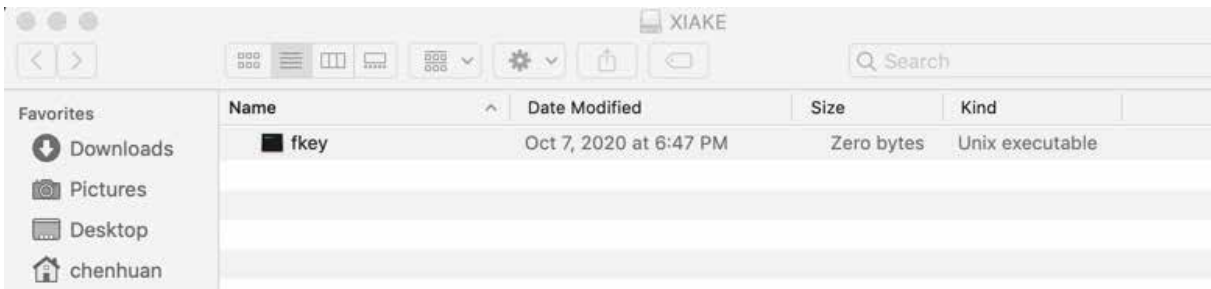

Figure 8-5 "fkey" file is in the root-directory of the USB-stick

5) Then Press F1 to “Registration”, and system will ask if the USB-stick have the “Fkey” file? We Press Enter key and system registrate automatically.

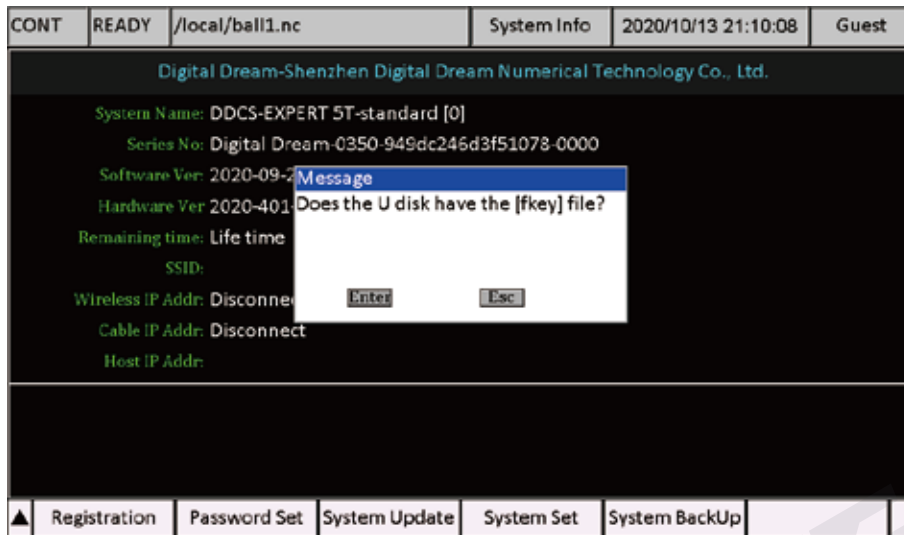

Figure 8-6 System ask if there is “fkey” file is in the root-directory of the USB-stick

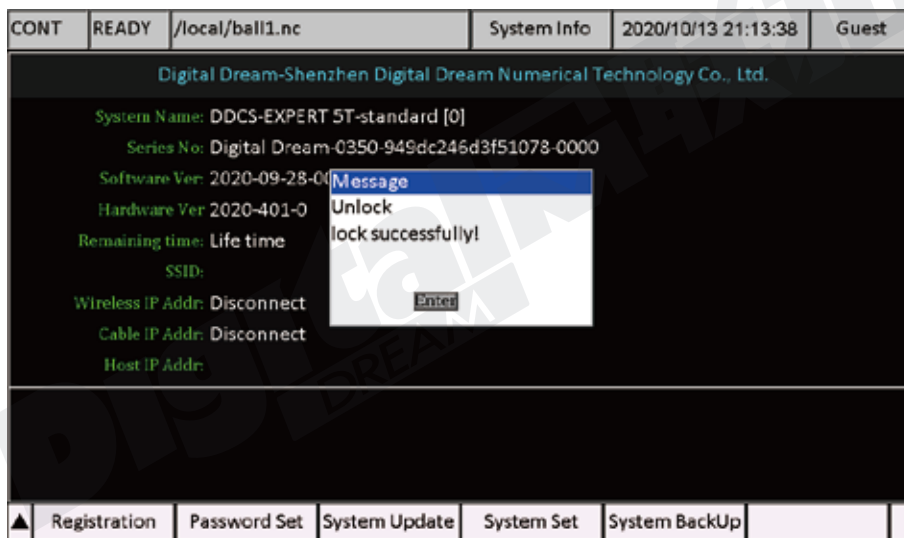

Figure 8-7 System Registrated the working time Successfully

If the left working time is less than 48 hours, when restart the controller, the controller will send a hint;

When the working time updated successfully, system will delete the fkey automatically;

If the updating is not successful, please check the series no. and the super admin password is right or not.

Very Important:

The working time and date calculation, is powered by a lithium battery. Because of the Air delivery control, the products with Battery always in limit. We will take off the battery if delivery by air. So please contact the factory for the information to buy the right battery and install it to the controller.

8.2 Password Setting

The default password for Opeartor : 666666

The default password for Admin: 777777

The default password for Super Admin: 888888

Here in the Password Page, we can reset the passwords.

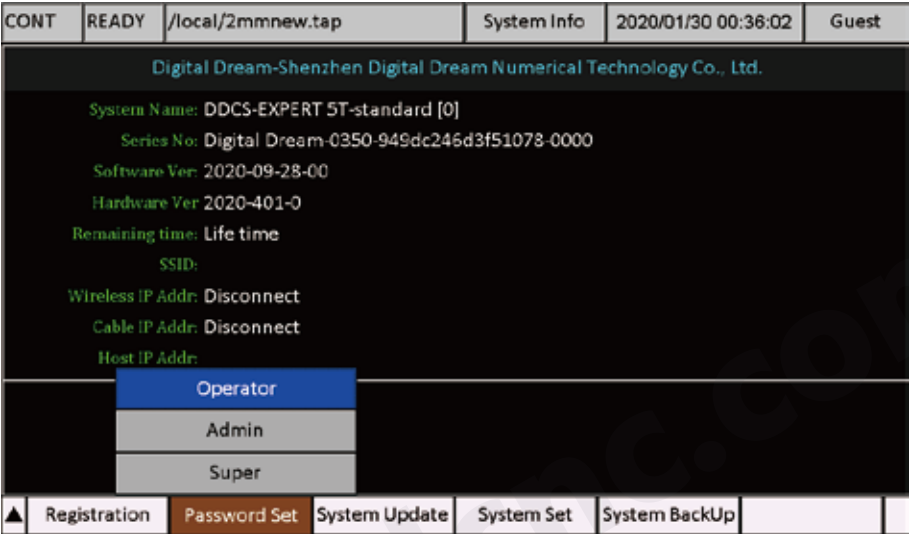

Figure 8-8 Password Reset Page

Press Enter it will ask you to enter the higher rights password. Input the default password, and write in the new password two times, the new password is active now.

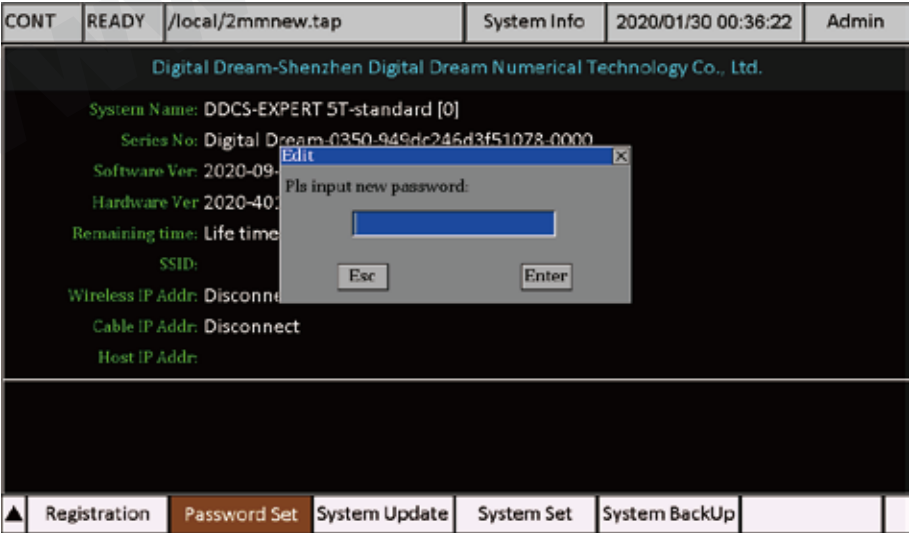

Figure 8-9 Input the new password one time

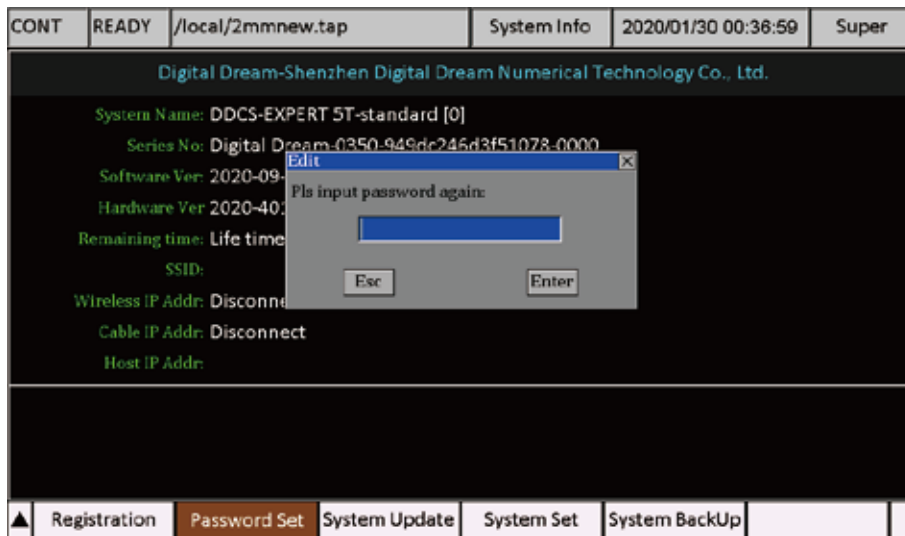
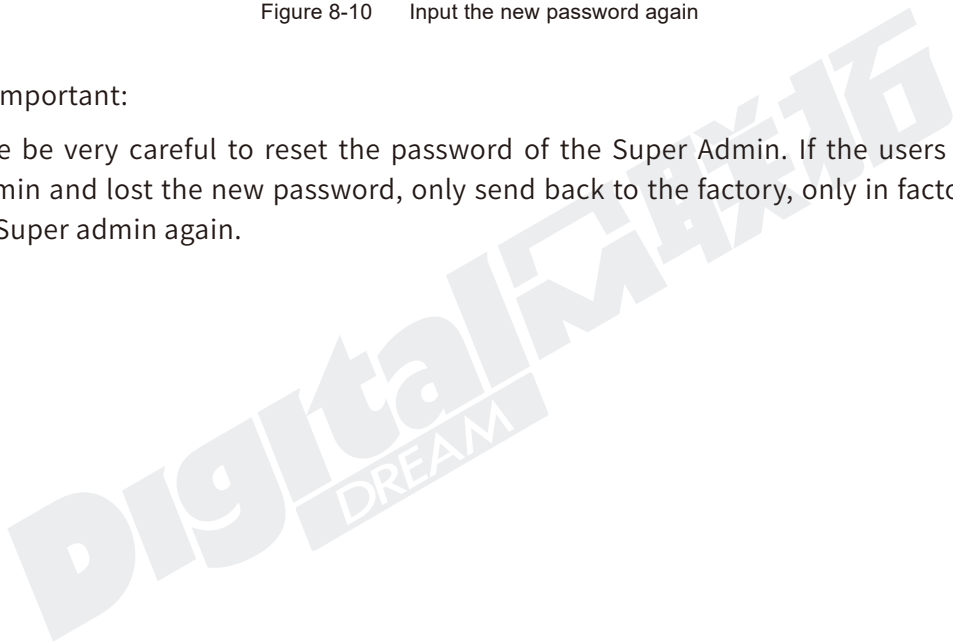

Figure 8-10 Input the new password again

Very Important:

Please be very careful to reset the password of the Super Admin. If the users reset the Super Admin and lost the new password, only send back to the factory, only in factory we can reset the Super admin again.



8.3 System Update (System Software Update)

According to the customer feedback, we will endeavour to update the software for DDCCS-Expert to enhance the performance, fix the bugs or add new features always. In order for customer to download the latest firmware, please visit our website :

www.ddcnc.com

or our Facebook Forum:

https://www.facebook.com/groups/1724999967517167/?ref=group_header

or join our forum

<http://bbs.ddcnc.com/forum.php>

There you can find the latest version software for DDCCS-Expert .

In the Main Page of the “System Info” , we can check here the Software version.

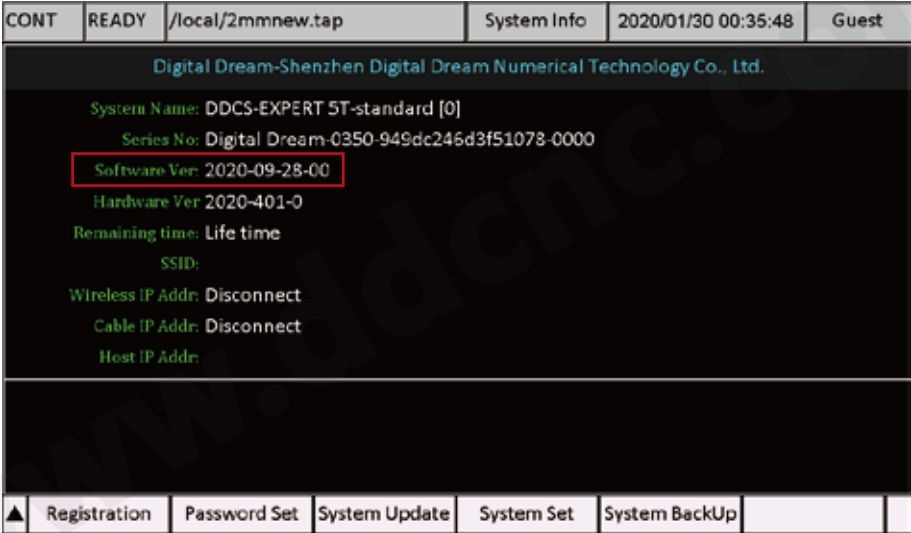

Figure 8-11 Software Version

Download the firmware upgrade file to your computer and prepare a totally empty USB key. Best is to quickly reformat the USB key to MS-DOS FAT32 (right click on the USB key icon and choose Format. Follow the prompts)

After downloading the firmware file check the file name, if download from www.ddcnc.com, it may look like this:

install(2020-09-28-00).rar (example)

If download from the facebook team (https://www.facebook.com/groups/1724999967517167/?ref=group_header) , it may look like this or similar:

install(2020-09-28-00)-rar (example)

This is done to allow the download. Files called “.RAR” are sometimes blocked.

Change the file name to
install(2020-09-28-00).rar (example)

Now your zip program can recognise the file as a compressed file and you can decompress it to the USB key. Please note the upgraded file should be in the Root-directory in the USB Stick and the file name must be “install”:

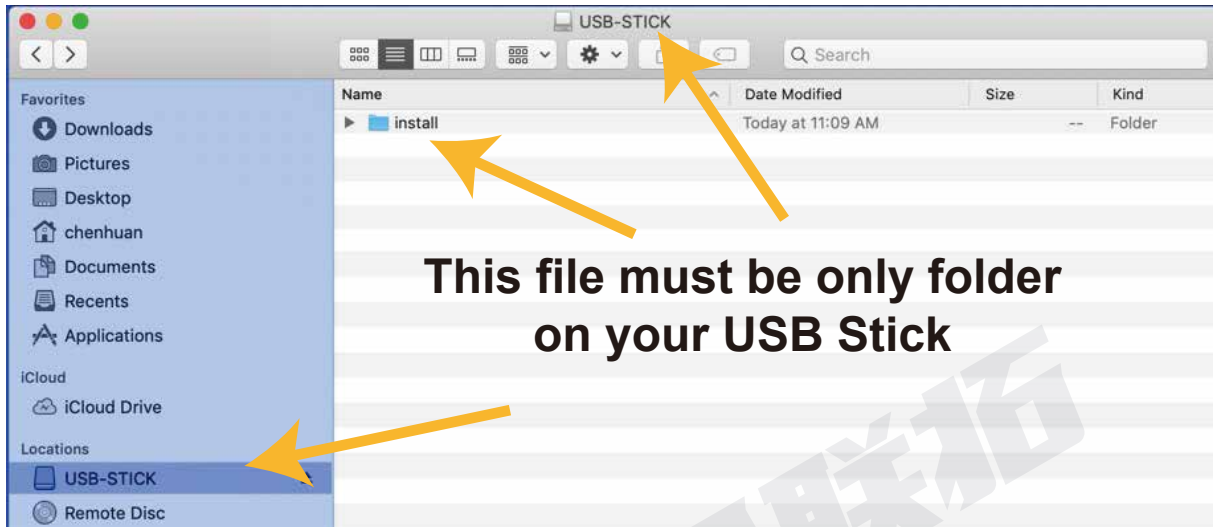

Figure 8-12 Position of Software file

Important:

Because we already delete the setting file from the Install software, When upgrading, the entire configuration will be not replaced. Then you can keep your personal Setting file.

But if you need the Default setting file, you can contact factory ask for it.

Please note the upgraded file should be in the Root-directory in the USB Stick and the file name must be “install”.

Now your USB key is ready for action.

DDCS-Expert Controller has two way to update the software:

A: Update the software when Power On.

1) Shut down your DDCSE controller for 10 seconds. Insert the USB key into the USB port of your DDCSE controller .

2) Start your DDCSE controller. The controller will read the INSTALL folder on the USB key and upgrade automatically. The screen will be blocked for about 30 seconds, then the controller will start with the new software.

On the Main Screen lower right you can see the firmware version the controller is using.

After upgrading successfully, don't forget to remove the Intsall folder from the USB key. If you do not remove the INSTALL folder the controller will update again next time you start the controller.

B: Update the software in the System update page.

- 1) Go to Main Page of “System Log” as the figure 8-1; And press F3 key of “System update” ;
- 2) The controller will ask “Does the U disk have the [install] folder” , Press Enter key;
- 3) The controller will read the INSTALL folder on the USB key and upgrade automatically. The screen will be blocked for about 30 seconds, then the controller will restart with the new software.

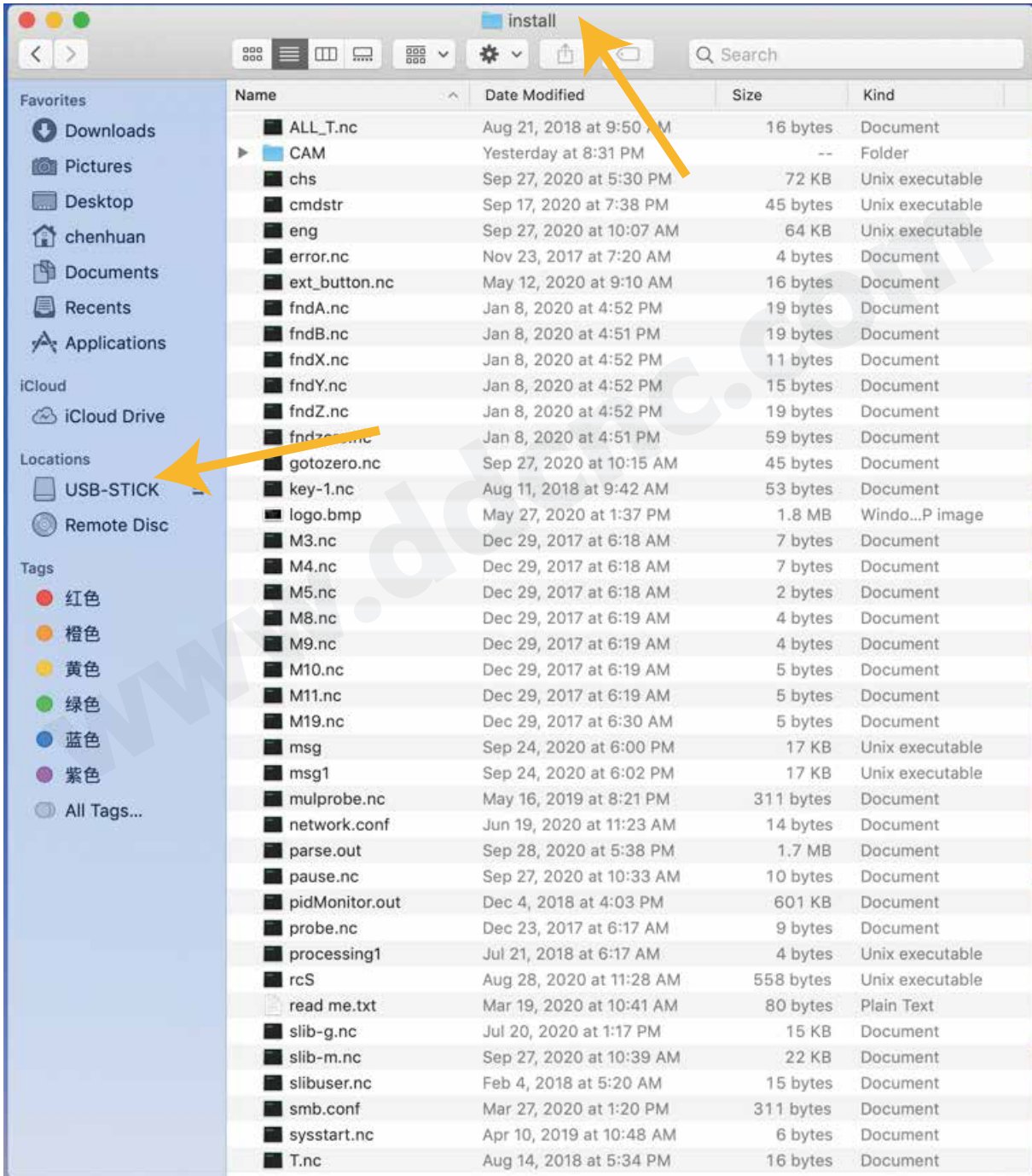

Figure 8-13 The files a INSTALL folder included

8.4 System Set

IN the System Set Page, we can set the system time, build the the network by Ethernet, and build the wireless network.

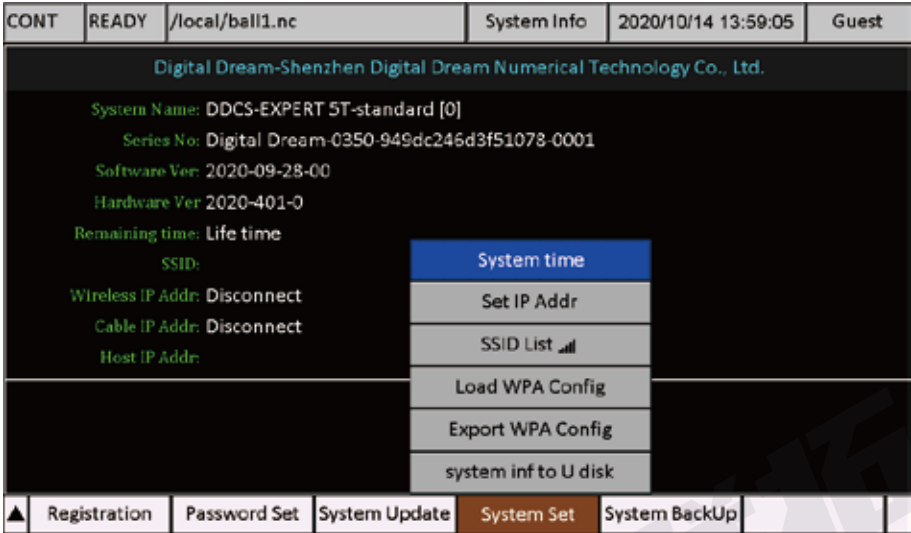

Figure 8-14 System Setting Page

8.4.1 System Time Setting

The system Time setting format is YYYY. MM. dd. HH. mm. ss:

YYYY: 4 digits to show the Year, such as 2020, 2021 ect;

MM: 2 digits to show the month, such as 01, means the January, 12 means the December;

dd: 2 digits to show the date, such as 02, means 2nd of the moth; 30 means the 30th of the month;

HH: 2 digits to show the hour;

mm: 2 digits to show the munits;

ss: 2 digits to show the seconds.

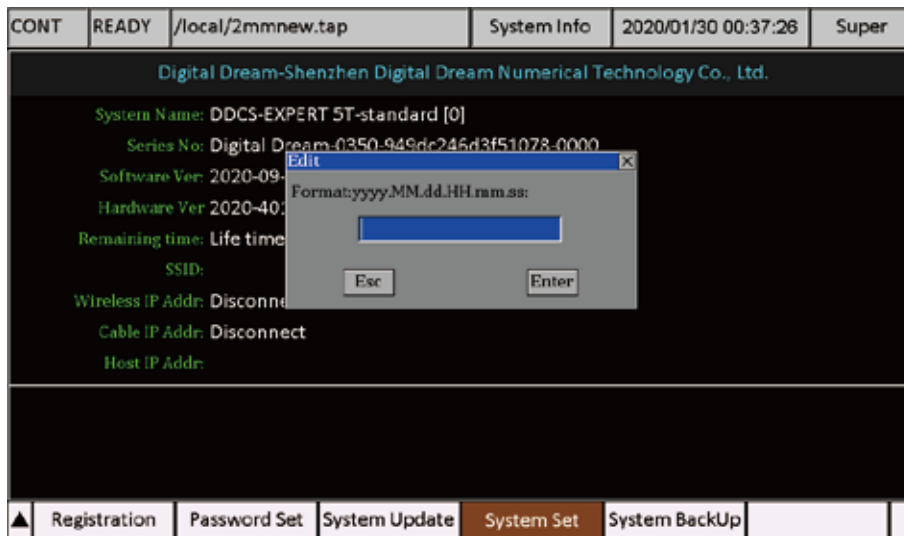

Figure 8-15 Setting the system time

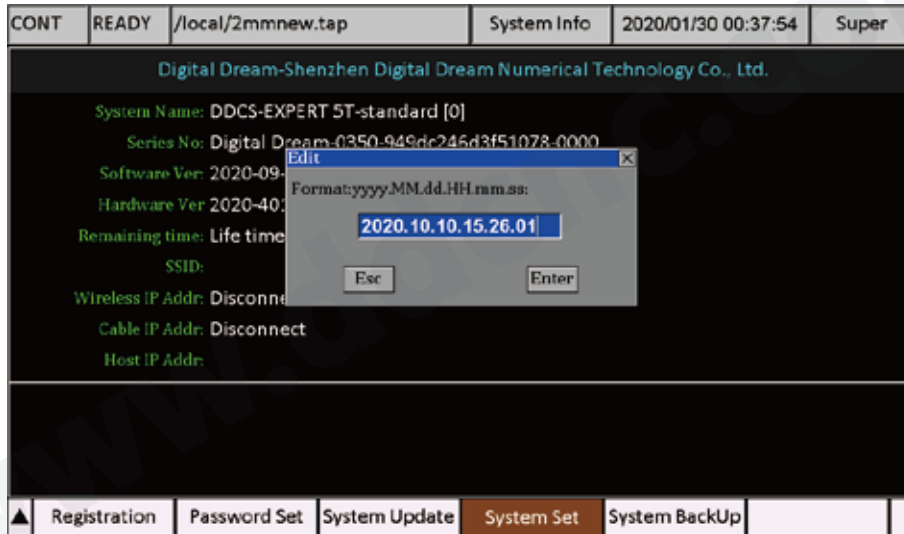

Figure 8-16 Input the settings

Very Important:

The working time and date calculation, is powered by a lithium battery. Because of the Air delivery control, the products with Battery always in limit. We will take off the battery if delivery by air. So please contact the factory for the information to buy the right battery and install it to the controller.

8.4.2 Set IP Address manually by Ethernet Cable

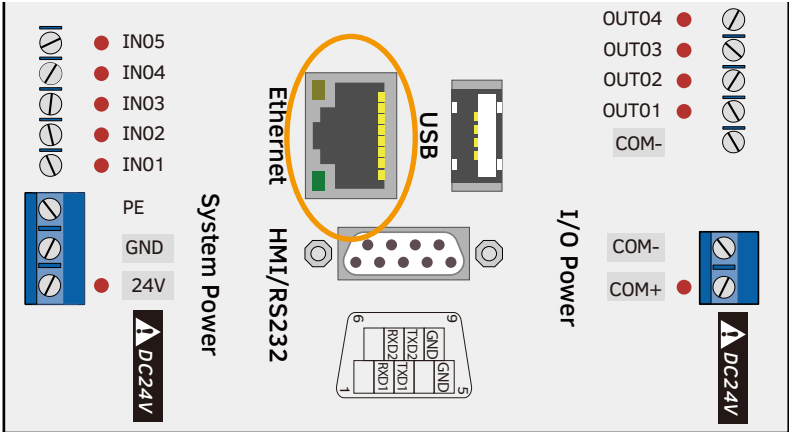

Figure 8-17 Build the Network by Ethernet

Firstly we need a Ethernet cable to connect with the DDCS-Expert and the computer. If the Network building properly, the Net LED turns red.

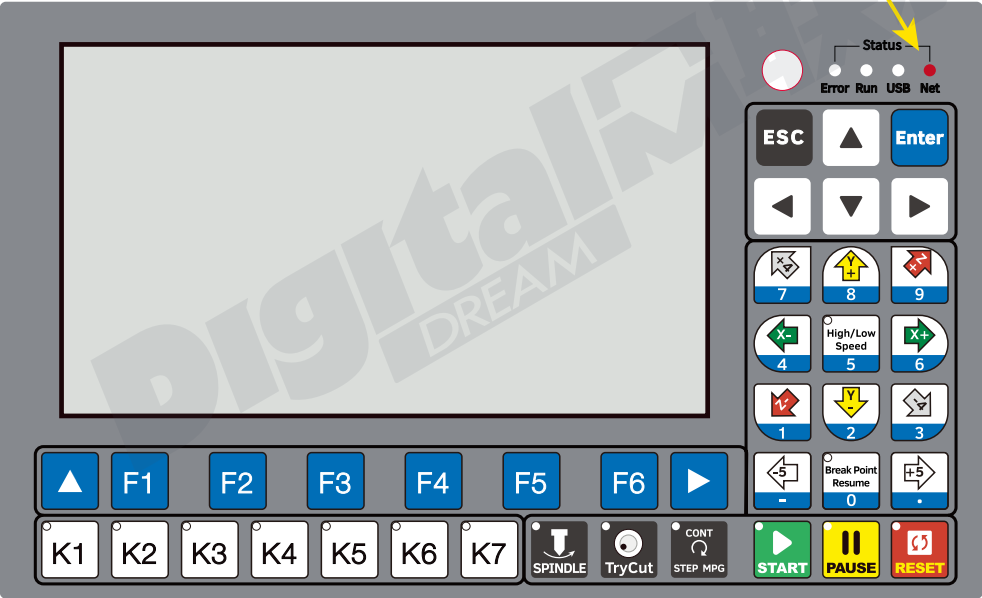

Figure 8-18 Network LED shows the status

1) Computer (Host) Configuration

Step 1: Use an Ethernet Cable to connect the DDCSE controller and the computer;

Step 2: Go to Setting -> Network and Internet -> Network Connections in computer.

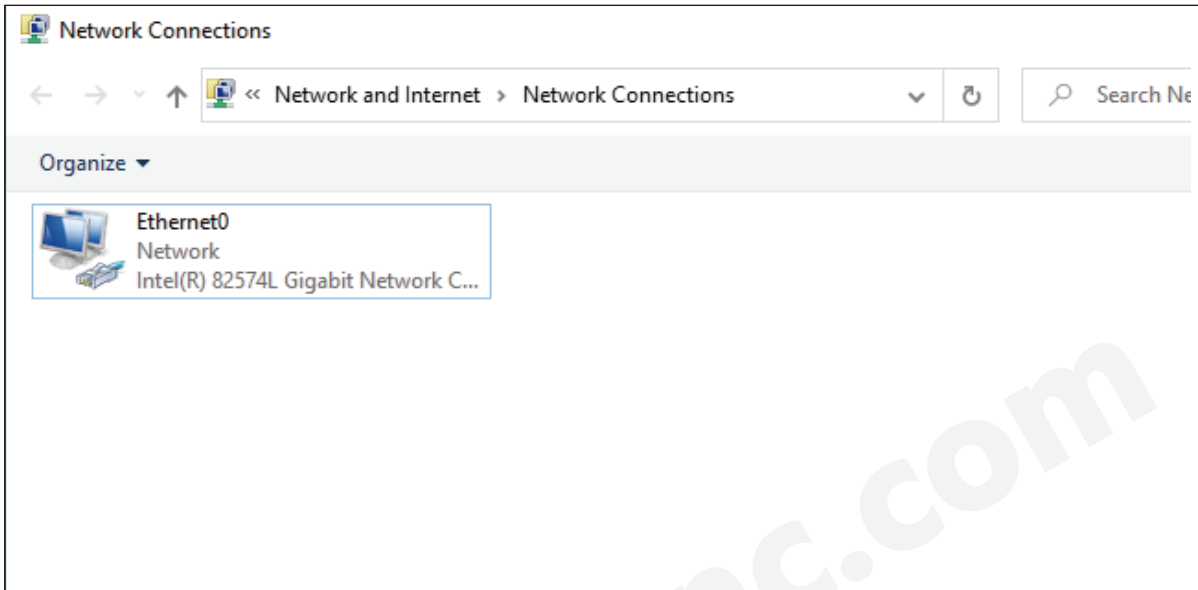

Figure 8-19 Find the Network Connections in Computer

Step 3: Right click and hit “Properties” and it pop up the windows and double click “Internet Protocol Version 4 (TCP/IPv4)” as the Figure 8-21:

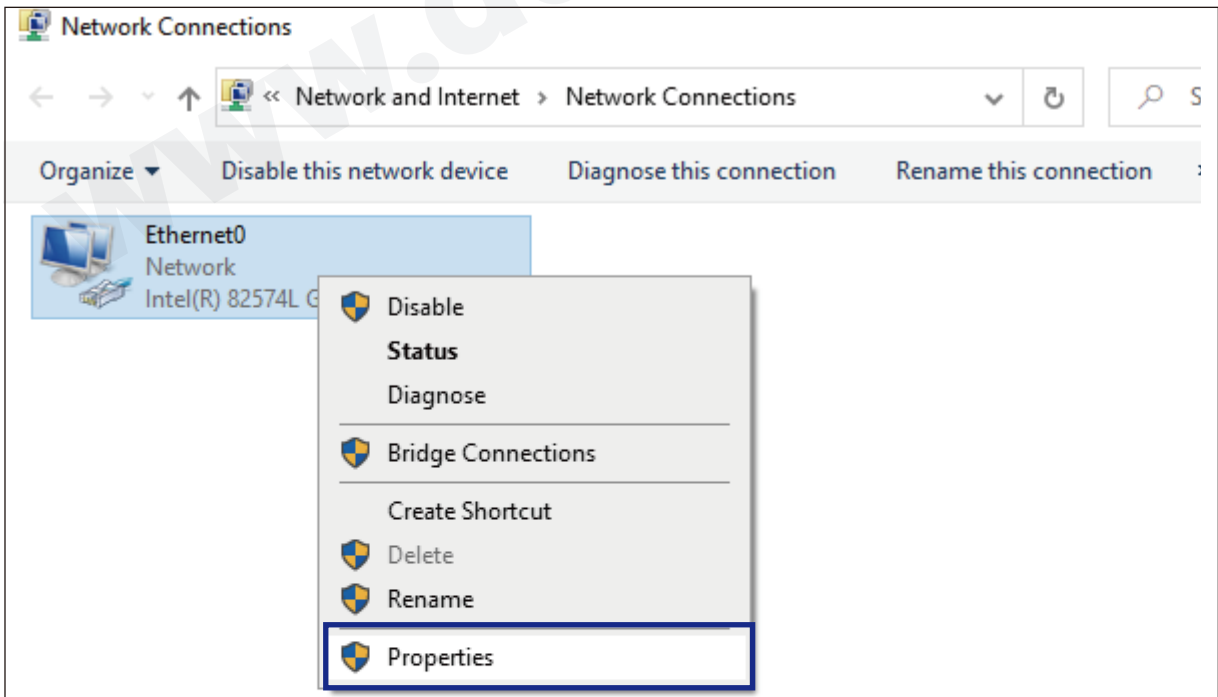

Figure 8-20 Properties

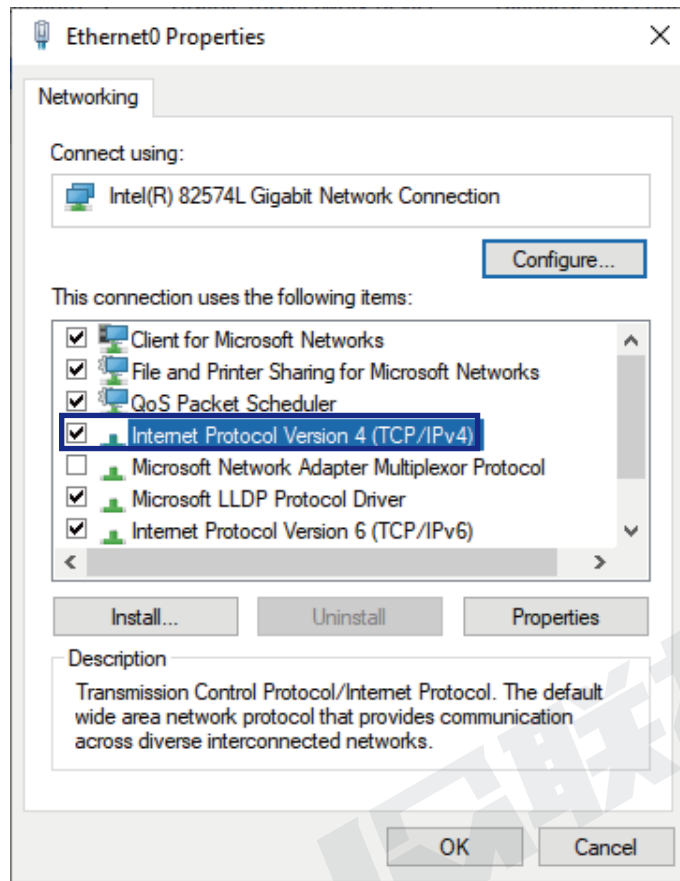

Figure 8-21

Step 4: Set the IP address and Subnet mask as Figure 8-22:

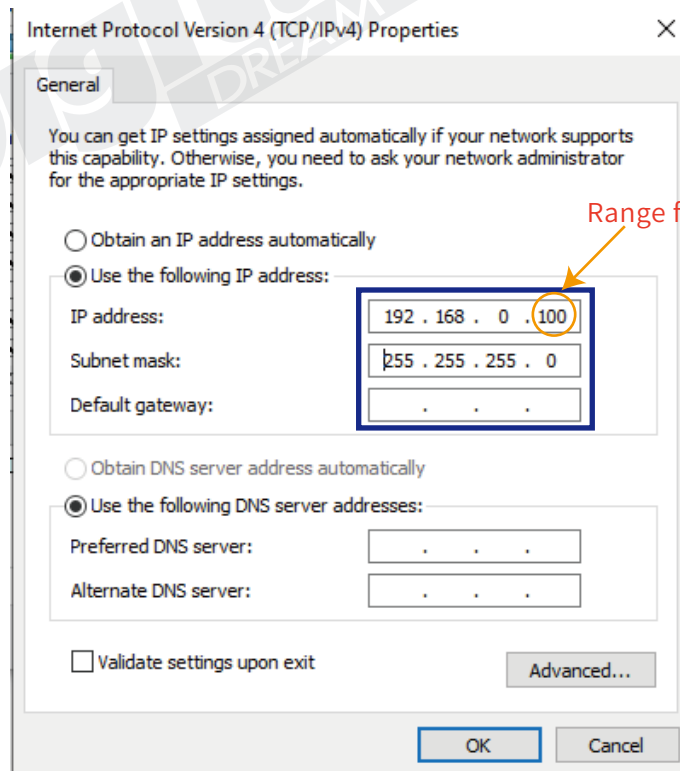

Figure 8-22 Set the IP address

Step 5: Turn Off the Firewall & network protection:

Go to Setting -> Update & Security -> Windows Security -> Firewall & network protection, and turn off the firewall:



Figure 8-23 Turn off the Firewall of the computer

Step 6: Create a “Share” folder:

Go to Settings -> Network and Internet -> Network and sharing center -> change advanced sharing settings, “Turn on network discovery” and “turn on file and pinter sharing”, as Figure 8-24 and 8-25 shows;

Then in your computer, you can create a folder name it as “share”.

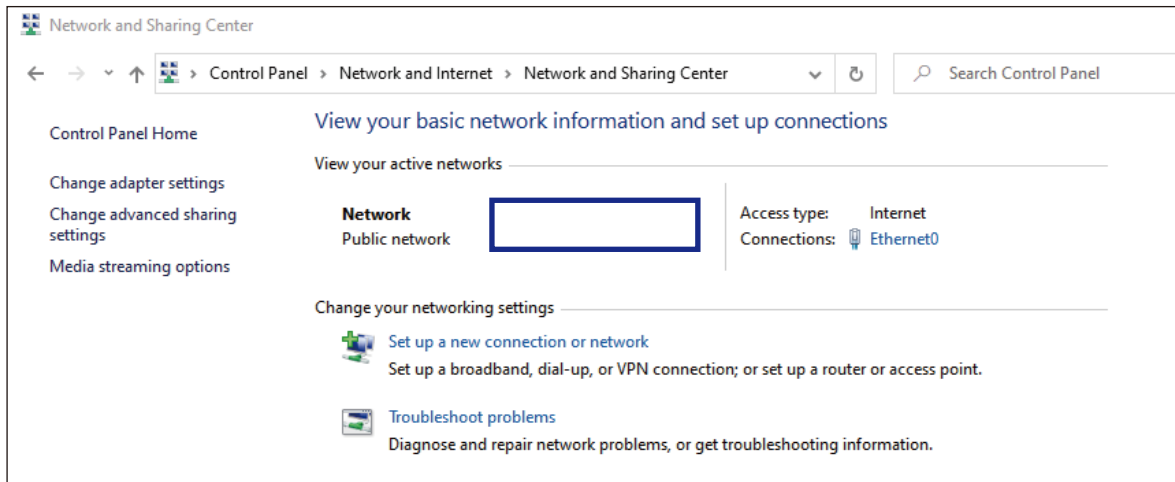

Figure 8-24

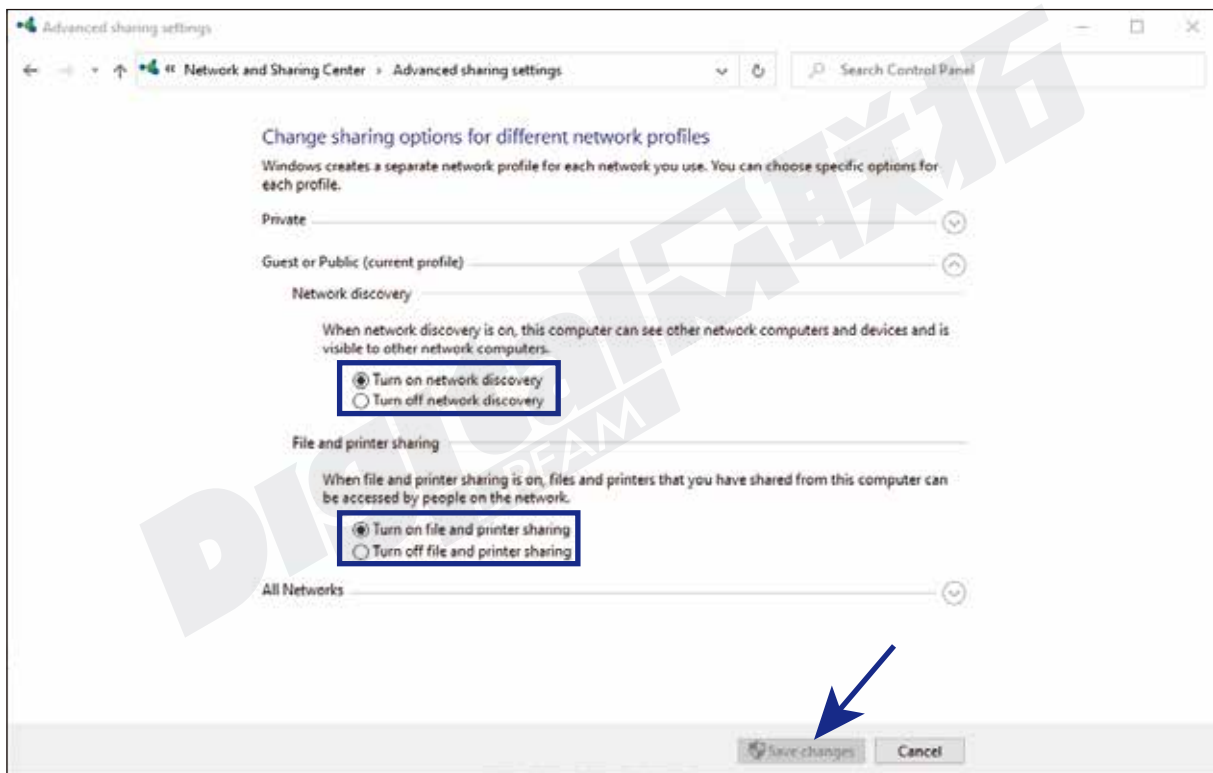

Figure 8-25

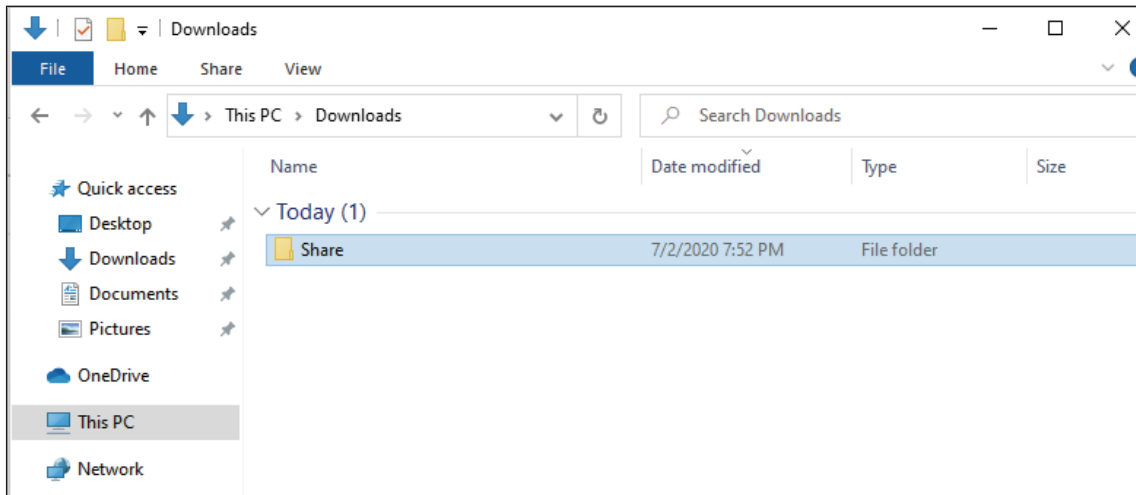

Figure 8-26

Step 7: Set the folder as “share” folder:

- 1) Right click the folder and click “Properties”, the “Properties” window popup as figure 8-28 shows;
- 2) click “Share button”, and “Network access” windows popup as figure 8-29 shows;
- 3) choose “Everyone”, and add it to the list;
- 4) Change the **Permission level of “Everyone” to “Read/Write”, and confirm it.**

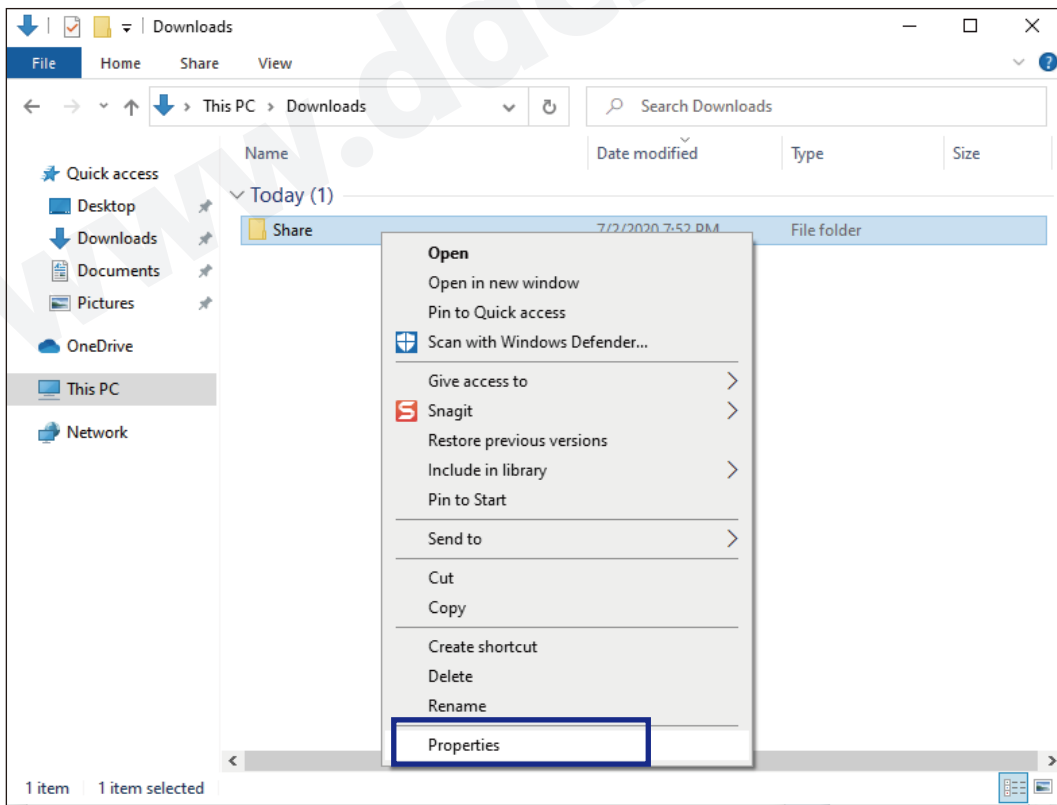

Figure 8-27

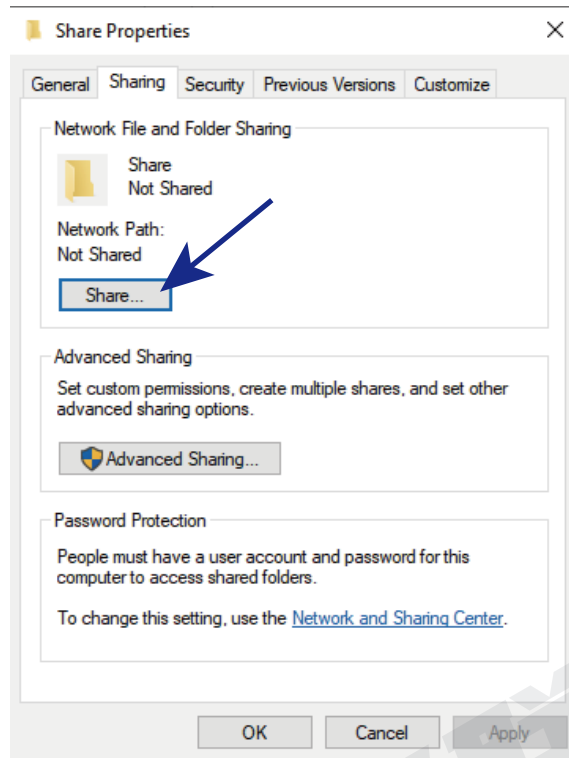

Figure 8-28

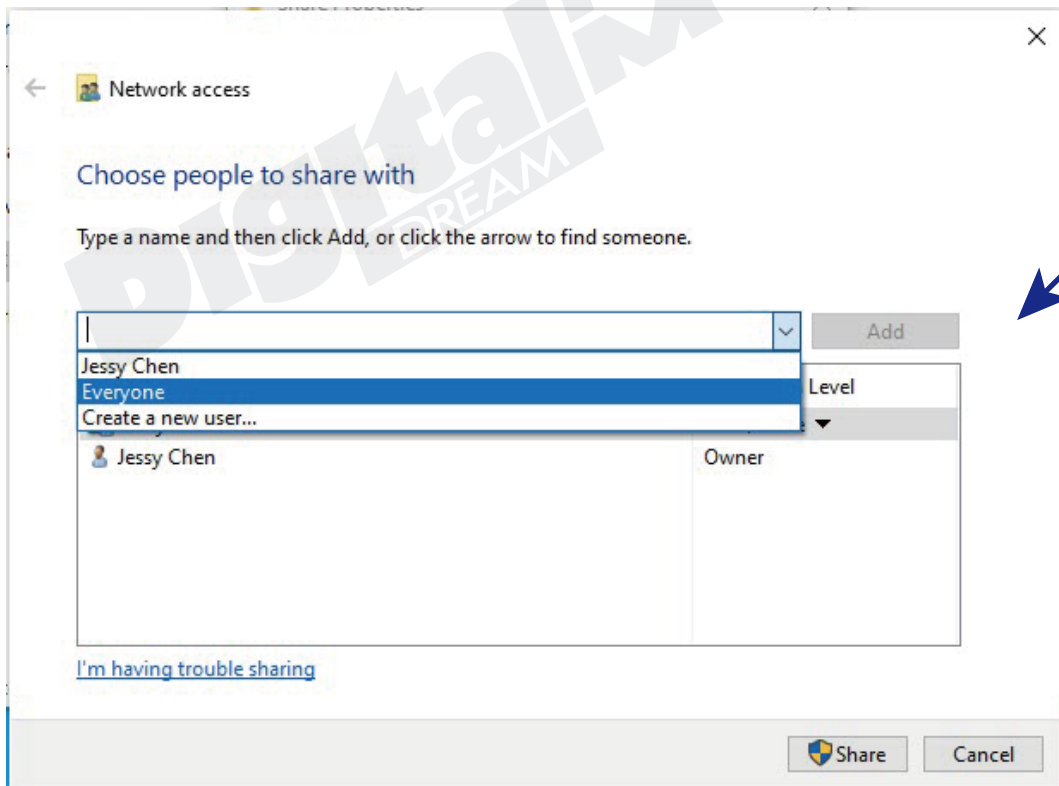

Figure 8-29

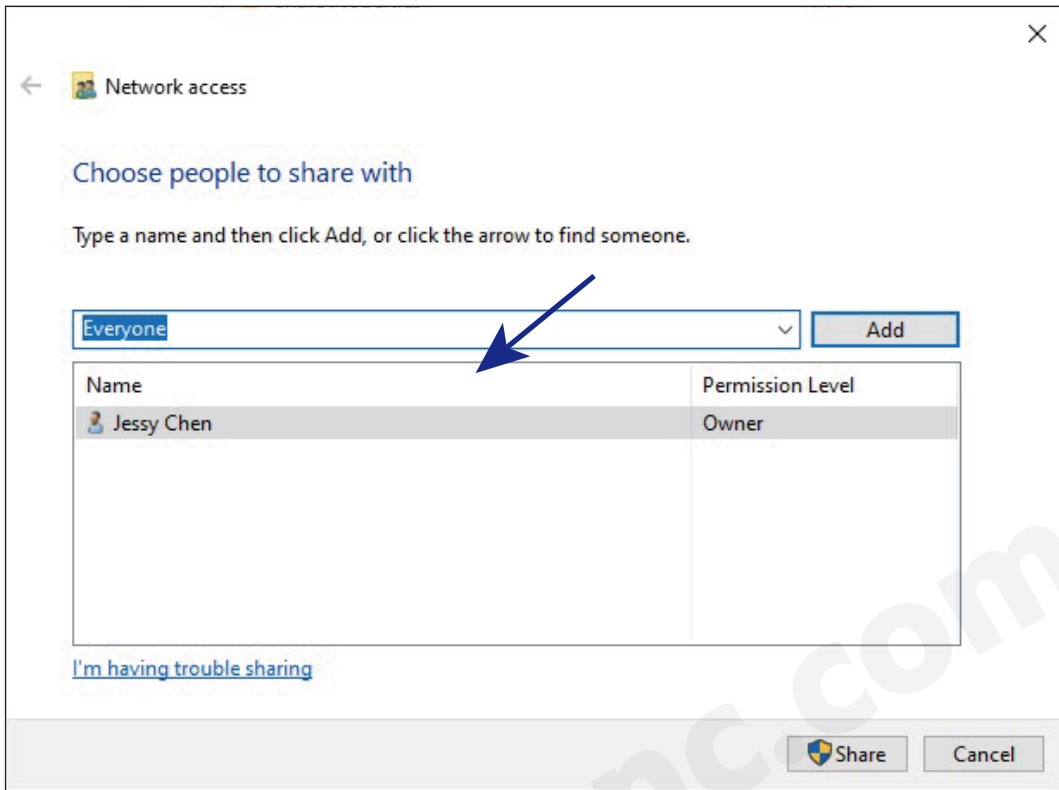

Figure 8-30 Chose "Everyone" and add it to the list

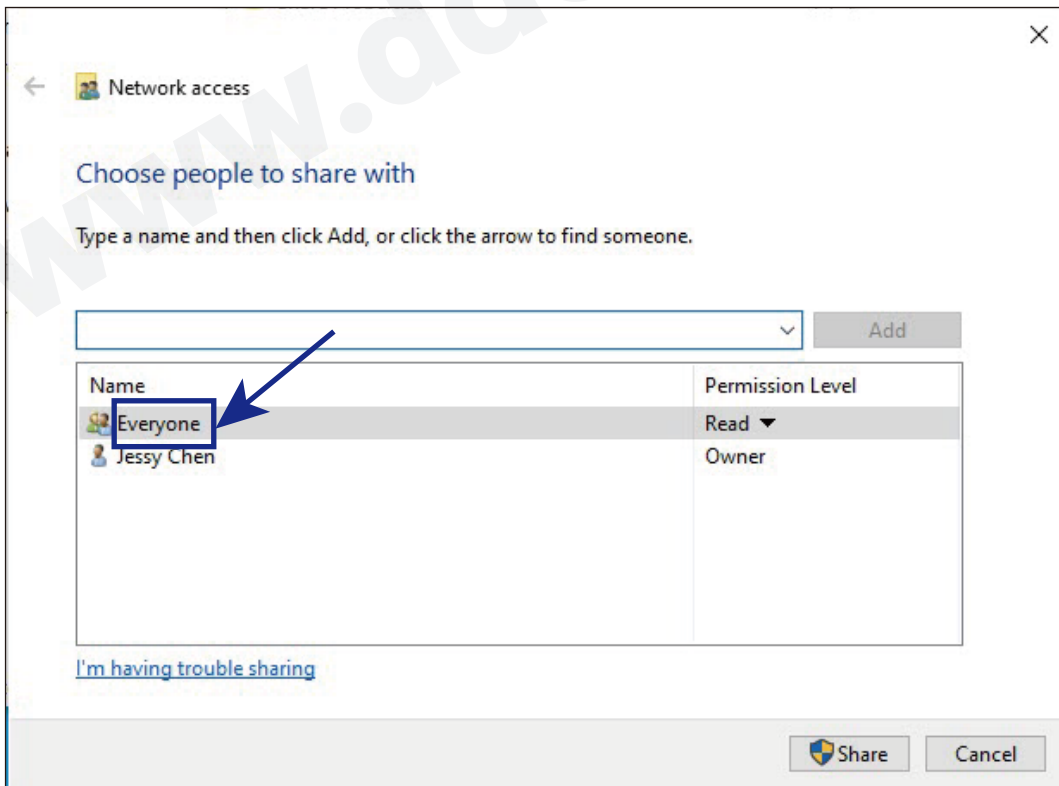

Figure 8-30 Change the Permission level of "Everyone"

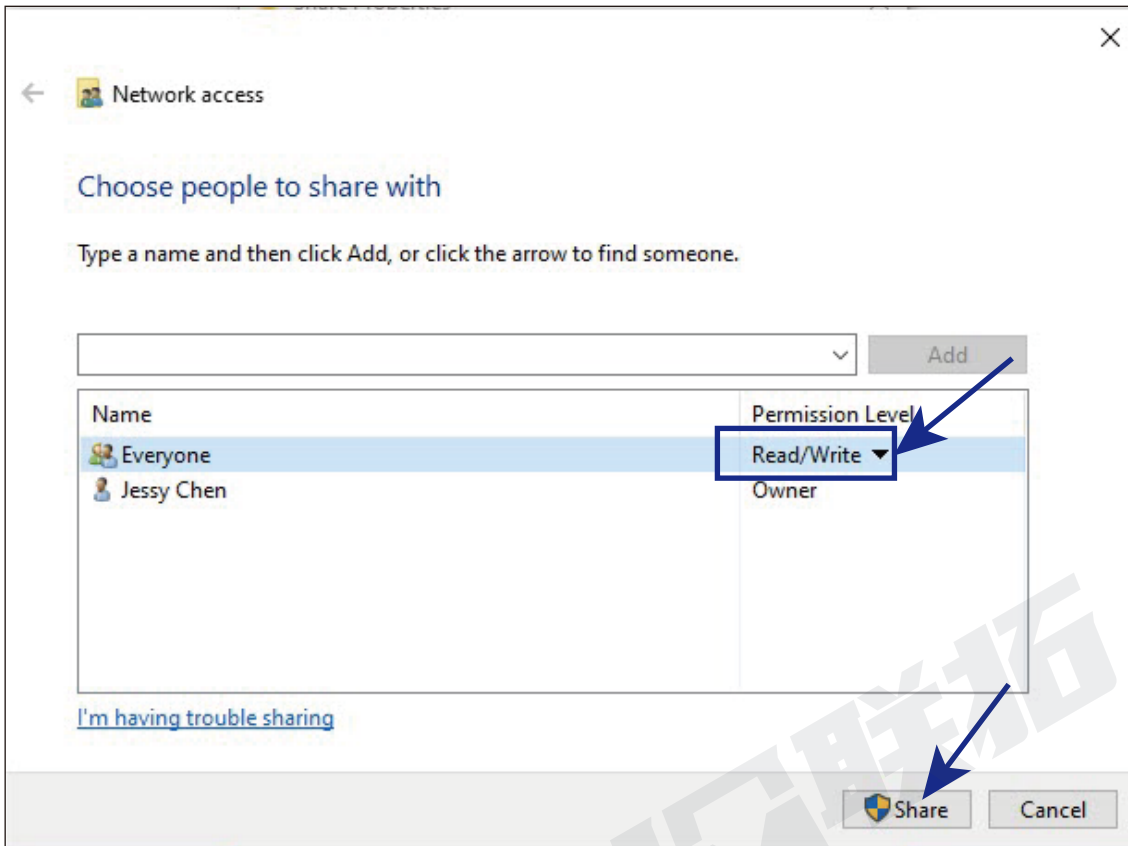

Figure 8-31 No forget to Click "Share"

2) Controller DDCSE Configuration

Step 1: Change the “Network Boot Mode” to “manu-IP”, it means the users can setup the IP settings manually in this mode.

- 1) Figure 8-32 shows the main page. This is Main Page, Press F3 to Parameter Page;
- 2) Find Para #284 “Network Boot Mode”, press “Enter”;
- 3) Password window pop up, please input the Admin password to choose “manu-IP” .

CONT	READY	/udisk-sda1/ball1.nc	Monitor	2000/11/12 07:40:23	Super
G54		Mach		Abs	FRO 100%
X		42.750		42.750	SRO 100%
Y		0.000		0.000	SJR Low 100%
Z		62.650		62.650	Feed Rate 0 3000
A		3.416		3.416	Analog S 0 14000
B		0.000		0.000	Cur Tool T1
0:G40 G17 G49 G80 G90 G54					Total No. 0
1:G00 X3. Y0.0 S24000 M03					Cur No. 0
2:Z10.					Cycle Times 0
3:G01 Z3.1 F1000.					Work Time 00:00:00
4:G01 X2.996 Z2.948 F3000. M08					G49 H 0
Monitor		Program		Param	IO
				System Log	System Info

Figure 8-32 Go to Param Page

CONT	READY	/udisk-sda1/ball1.nc	Param	2000/11/12 07:39:50	Super
Param List:					
		No.	Note	Value	
Machine		0241	Enable buzzer feedback	Yes	
Manual		0244	Enable realtime toolpath	Yes	
		0245	Toolpath mode	Statue	
Process		0247	Interpolation period	0.005	
Spindle		0248	LOGO display time	0.100	
		0261	X-axis rotation angle in 3D toolpath mode	0.000	
IO		0262	Y-axis rotation angle in 3D toolpath mode	0.000	
Home		0263	Z-axis rotation angle in 3D toolpath mode	0.000	
Probe		0266	Serial 1 baud rate	B2400	
		0267	Serial 1 baud rate	B2400	
Hard Limit		0278	USB keyboard type	keyboard	
Software limit		0279	Barcode file location	Local	
MPG		0283	Barcode scanning processing	No	
Backlash		0284	Network boot mode	Close	
Tools		Range:	[0~2]	Active:	Immediately
		User:		User:	Admin
System		Details:			
▲ Param List Search Param Backup Param Restore					

Figure 8-33 Find the Parameter #284

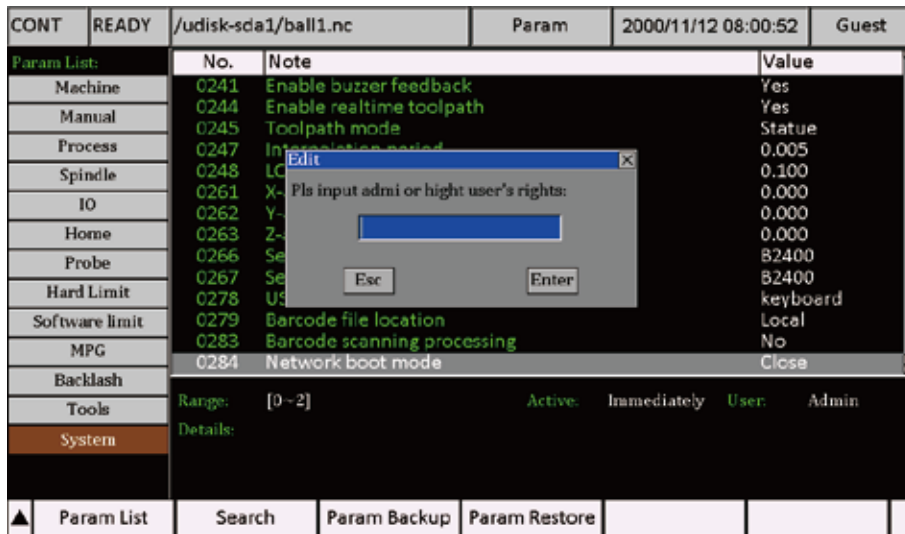

Figure 8-34 Password window pop up

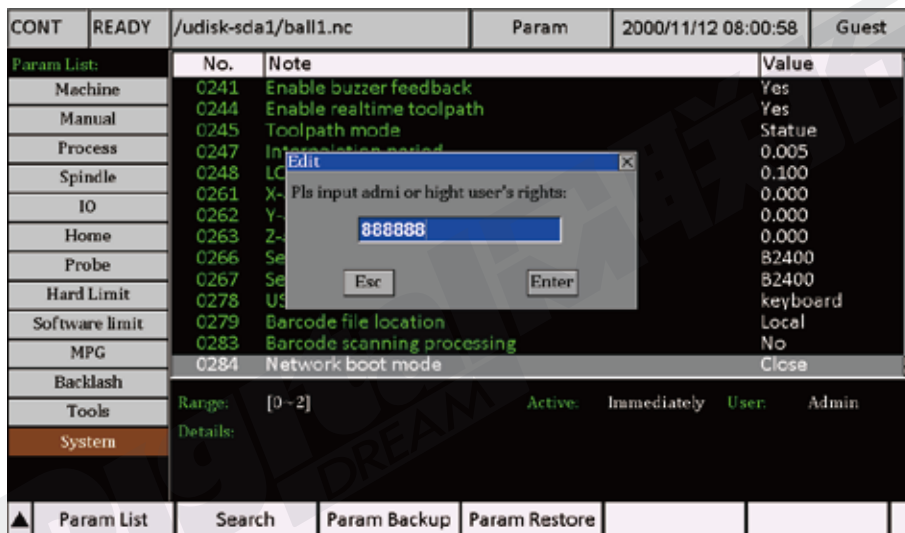

Figure 8-35 Input Admin Password to continue

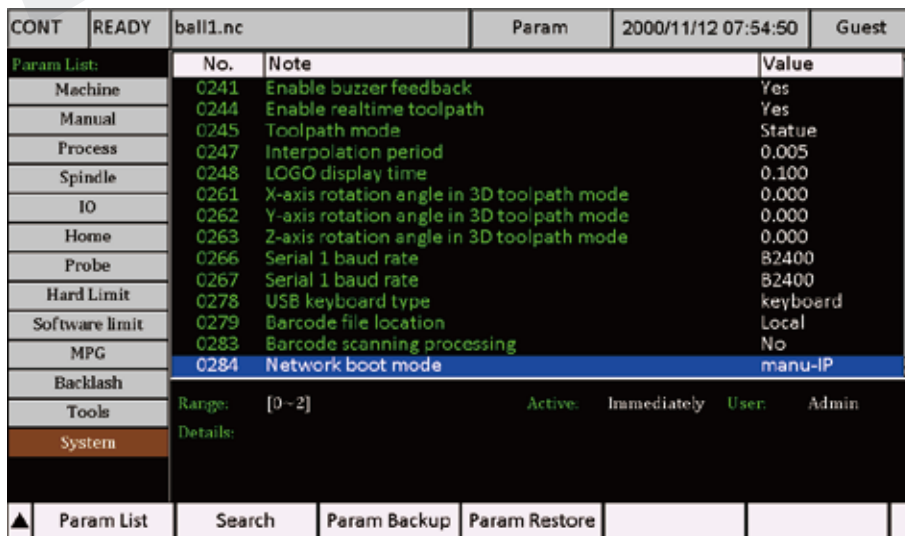

Figure 8-36 Changed the mode to "manu-IP"

Step 2: Set the IP address

- 1) Go back to Main page and Press F6 To System Info,as figure 8-37shows;
- 2) Press F4 and choose “Set Ip Addr” as Figure 8-38 shows;
- 3) Press Enter and move down to “Cable IP Addr”,it shows as Figure 8-39 shows;
- 4) Press Enter key and input the controller IP address “192.168.0.99”;
- 5) Press F4 again and Go to “Host IP address” as Figure 24 shows;
- 6) Press Enter and input Computer (Host) IP address “192.168.0.100” as Figure 8-41 shows;
- 7) Now,remember,now restart the controller,never forget this step,go to “System info” Page again,it just shows as the Figure 26,that means the IP setting is succesful.

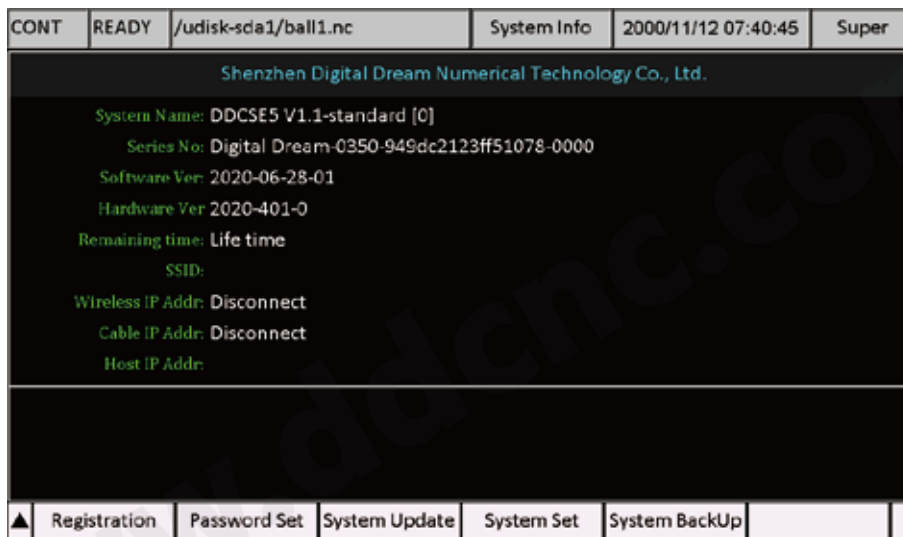

Figure 8-37 “System info” Page

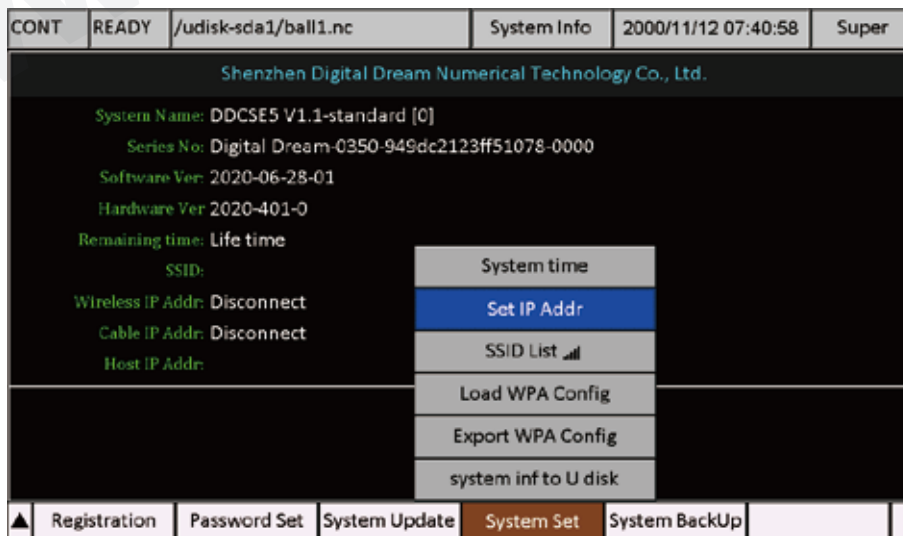

Figure 8-38 Set IP Address

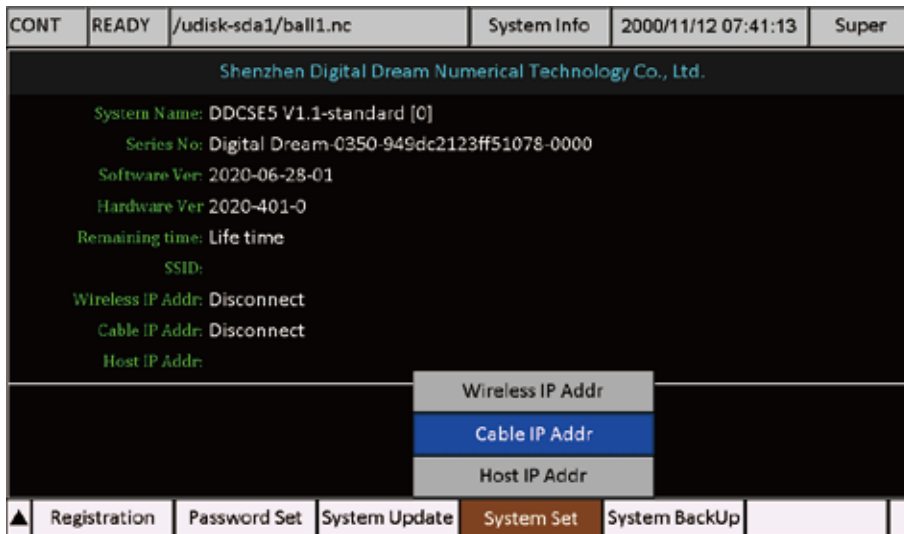

Figure 8-39 Cable IP Address

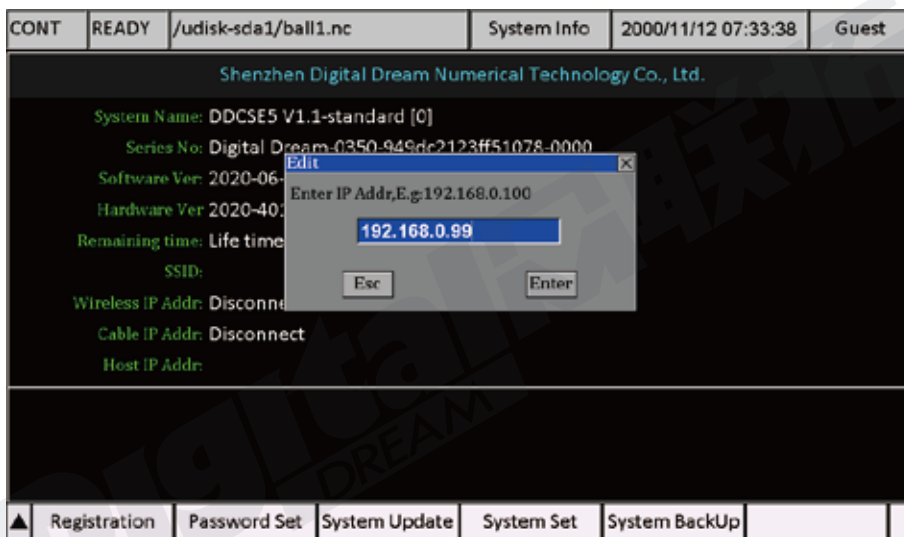

Figure 8-40 Enter controller IP address "192.168.0.99"

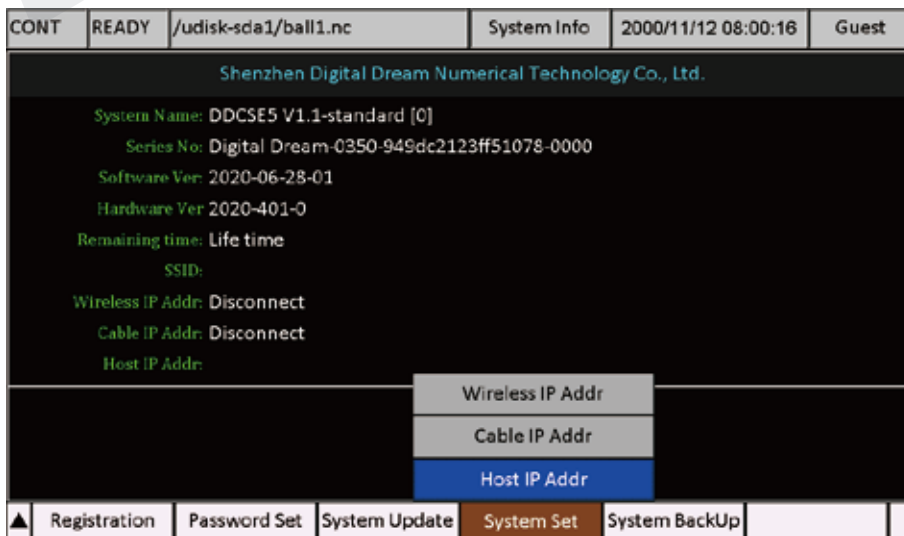

Figure 8-41 Go to Host IP address

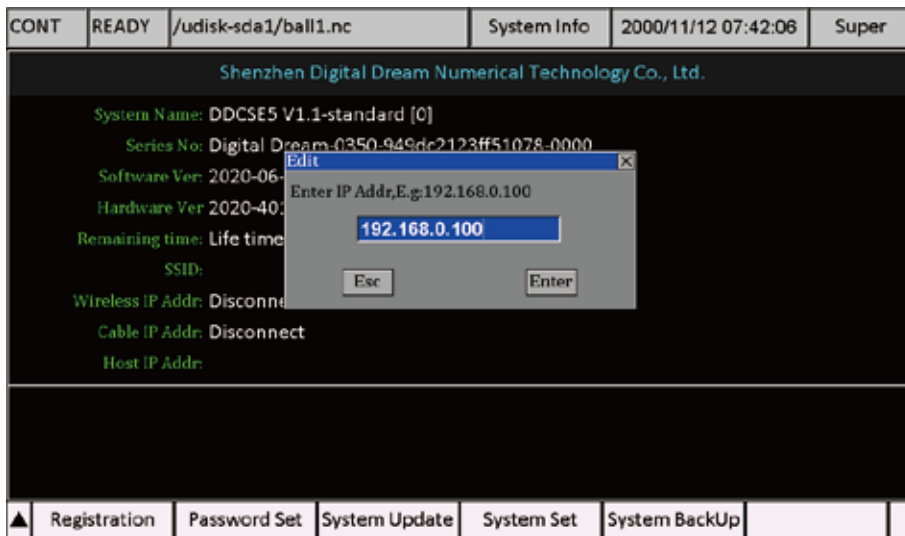

Figure 8-42 Input the Host Computer IP address

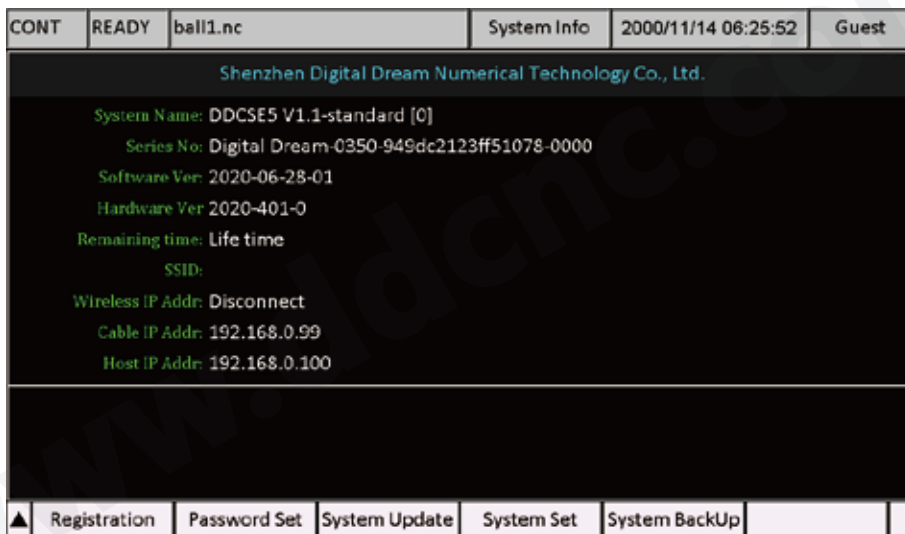

Figure 8-43 After Restart we can see the IP setting is successful

3) Check the files from the Host (computer)

- 1) Copy the files you need into the folder “share” on the computer as Figure 8-44;
- 2) In the Page of Program, press the “Swtich disks” button(F1), switch to “Net Disk”, and we can see the files as Figure 8-45;

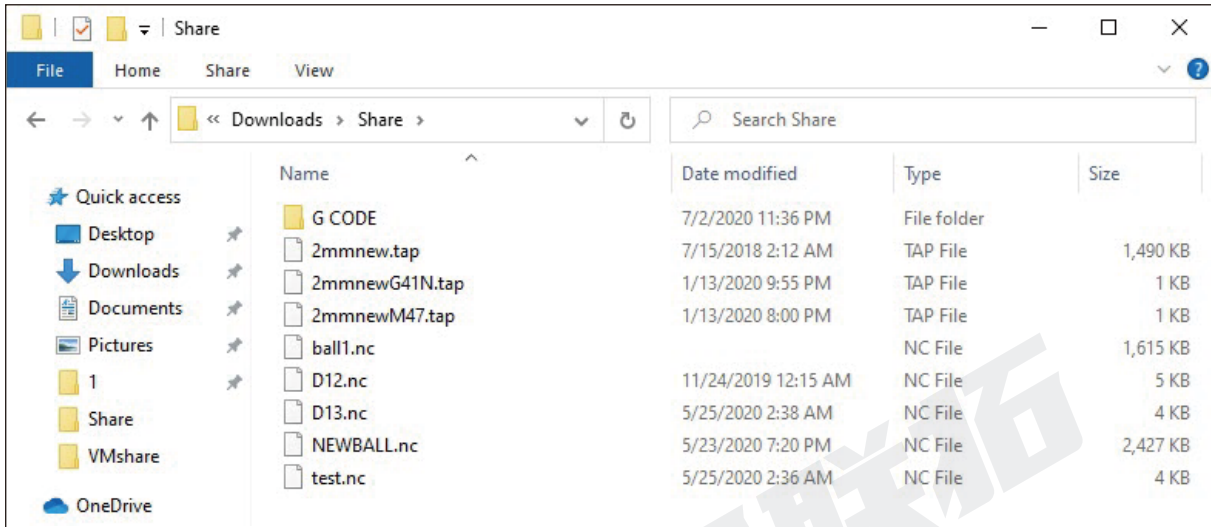

Figure 8-44 The files in the Share folder

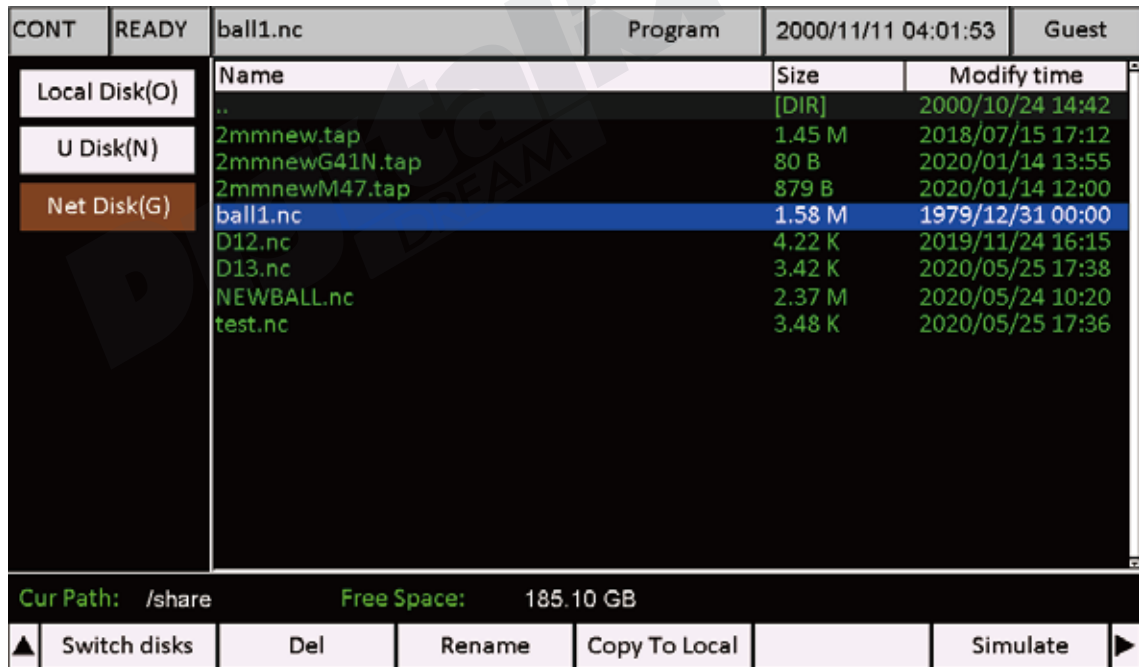

Figure 8-45 Net Disk shows the files from Computer

Please Note: U-disk and Net Disk cannot active at the same time.

8.5 System BackUp

In the System Back Up, there are 3 options:

- 1) BackUp: It will copy the INSTALL folder of this controller system, to the USB-stick;
- 2) Clear Cache: System clear the cache, that will make the system running quicker;
- 3) Clear Local: It will delete all the files in the Local memory.

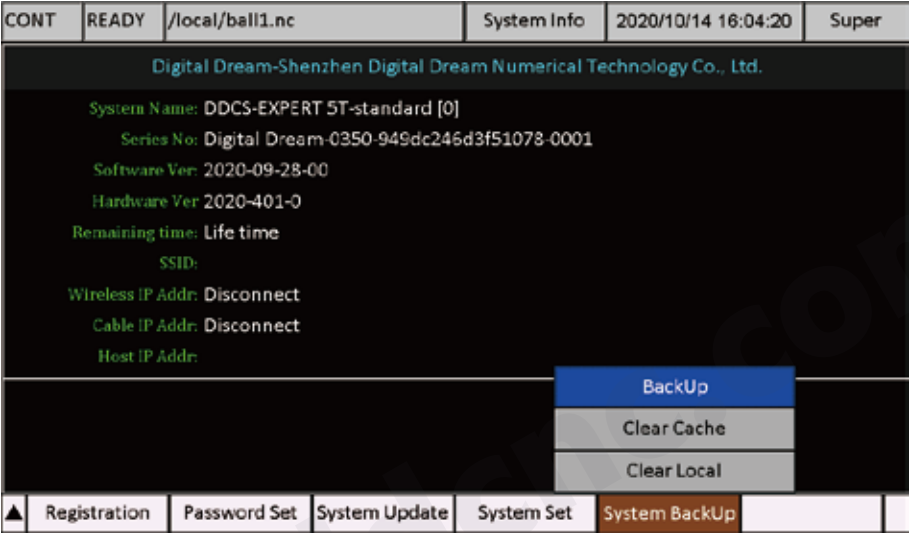

Figure 8-46 The System BackUp Page

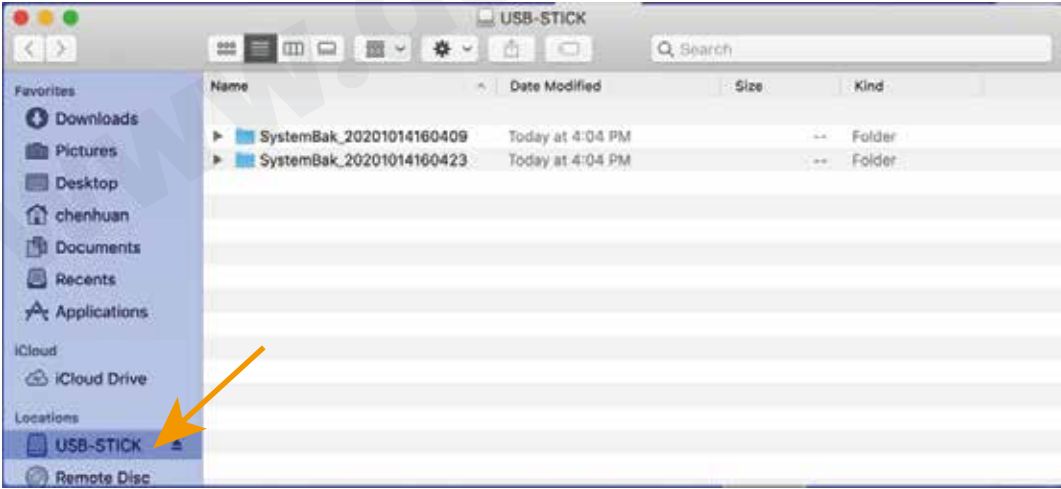

Figure 8-47 After the System BackUp, the install file is saved in the root directory in the USB-Stick

9 G Code and M Code

Command	Options	Description	Example of use	Description of the example
G0, G00	X Y Z A	Moves the axes to the point X Y Z A, at the speed specified in # 80	G0 X10 Y10 Z1	Quickly moves the axes to the point X10 Y10 Z1
G1, G01	X Y Z A	Moves the axes in line to the point X Y Z A, at the speed specified in F. If F is not specified, the speed from parameter # 76 is used.	G0 X10 Y10 Z1 F100	Moves the axes to the point X10 Y10 Z1 at a speed of 100
G2, G02 (mode1)	X Y Z I J K	Moving along the arc, clockwise, specified the center, at the speed specified in F. I, J, K are the coordinates of the arc center (x, y, z), relative to the end point (for G91.1) or in absolute coordinates G90.1), K can be omitted. X, Y is the end point of the arc. Z - for plunging into a spiral (end infeed). The starting point of the arc is given by the preliminary movement of the axes into it.	G0 X0.00 Y-50.00 ----- G2 X100.00 Y-50.00 I50.00 J0 F100	Draws half the circle, D = 100, from 0 to 180 degrees, clockwise, at a speed of 100
G3, G03 (mode1)	X Y Z I J K	Moving along the arc, counterclockwise, specified the center, at the speed specified in F. I, J, K are the coordinates of the arc center (x, y, z), relative to the end point (for G91.1) or in absolute coordinates G90.1), K can be omitted. Z - for plunging into a spiral (end infeed). The starting point of the arc is given by the preliminary movement of the axes into it.	G0 X100.00 Y-50.00 ----- G3 X0.00 Y-50.00 I-50.00 J0 F100	Draws half the circle, D = 100, 180 to 0 degrees, counter-clockwise, at a speed of 100
G2, G02 (mode2)	X Y Z R	Moving along an arc, clockwise, specified the radius, at the speed specified in F. R is the radius of the arc. X, Y is the end point of the arc. Z - for plunging into a spiral (end infeed). The starting point of the arc is given by the preliminary movement of the axes into it.	G0 X0.00 Y-50.00 ----- G2 X100.00 Y-50.00 R50 F100	Draws half the circle, D = 100, from 0 to 180 degrees, clockwise, at a speed of 100
G3, G03 (mode2)	X Y Z R	The movement along the arc, counterclockwise, specified the radius, with the speed specified in F. R is the radius of the arc. X, Y is the end point of the arc. Z - for plunging into a spiral (end infeed). The starting point of the arc is given by the preliminary movement of the axes into it.	G0 X100.00 Y-50.00 ----- G3 X0.00 Y-50.00 R50 F100	Draws half the circle, D = 100, 180 to 0 degrees, counter-clockwise, at a speed of 100
G4, G04	P	Stops processing for the number of milliseconds specified after P. In this case, the machine does not stop the spindle and does not pick up the tool	G4 P10000	Stops processing for 10 seconds
G17		Selecting the working plane X-Y	G17	Select the working plane X-Y
G18		Selection of working plane Z-X	G18	Select of working plane Z-X
G19		Selection of working plane Y-Z	G19	Select of working plane Y-Z
G20		Inch system selection	G20	Inch system selection
G21		Choice of metric system	G21	Metric system selection

Command	Options	Description	Example of use	Description of the example
G28	X Y Z A	Go back to the reference point. Works only with G91. The specified axes, first move to the specified point, then to the machine 0. If 0 is specified, then immediately into the machine zero. The not specified axes do not move.	G91 G28 X10 Y0 Z0	The X axis will first move 10mm to the right, then the XYZ axes will go to the machine axis 0. Axis A does not move.
G40	NO	Cancel tool radius compensation. The function does not work yet.	G40	Cancel tool radius compensation.
G41	D	Compensate the tool radius to the left of the path. D - is the tool number from the table.	G40	Compensates the tool radius 1, to the left of the path.
G42	D	Compensate tool length positively. H - the number of the instrument according to the table. The function does not work yet.	G42 D1	Compensates the length of tool 1 positively.
G43	H	Compensate tool length positively. H - the number of the instrument according to the table.	G43 H1	Compensates the length of tool 1 positively.
G44	H	Compensate for the length of the instrument is negative. H - the number of the instrument according to the table.	G44 H1	Compensates the length of tool 1 negatively.
G49	H	Cancel tool length compensation.	G49	Cancel tool length compensation
G53	H	malfunctioning, working analog G153	G44 H1	Compensates the length of tool 1 negatively.
G54 - G59	X Y Z A	Selecting the coordinate system	G54	Selecting a coordinate system
G73	X Y Z R Q I K	The cycle of step drilling with the full output of the drill, with the speed F. X, Y - the coordinates of the center; Z - is the distance from R to the bottom of the hole; R - drilling depth (usually, 0); Q - is the step size; I - distance of failure to return to G0; K - is the number of repetitions. The drill is retracted and fed at a speed of G0, which can be limited by parameters # 78 and # 79.	G83 X10 Y5 Z-7 R0 Q1,4 I0 K1 F300	Drills the hole at point X10 Y5, from 0 to 7mm, at a speed of 300 mm / min. The step size is 1.4mm, thus 5 steps are done. After each step, the drill is retracted by 1mm.
G81	X Y Z R K	Drilling in 1 pass, with speed F. X, Y - coordinates of the center; Z is the distance from R to the bottom of the hole; R - drilling depth; K is the number of repetitions.	G81 X10 Y5 Z-7 R0 K1 F300	Drills the hole at point X10 Y5, from 0 to 7mm, at a speed of 300 mm / min.
G82	X Y Z R K P	Drilling in 1 pass with a delay at the end (for better processing of the bottom), with speed F. X, Y - coordinates of the center; Z - is the distance from R to the bottom of the hole; R - drilling depth; K - is the number of repetitions, P - is the delay in milliseconds.	G82 X10 Y5 Z-7 R0 K1 P2000 F300	Drills the hole at point X10 Y5, from 0 to 7mm, at a speed of 300 mm / min. At the bottom of the drilling, the pause is 2 seconds.
G83	X Y Z R Q I K	The cycle of step drilling with the full output of the drill, with the speed F. X, Y - the coordinates of the center; Z - is the distance from R to the bottom of the hole; R - drilling depth (usually, 0); Q - is the step size; I - distance of failure to return to G0; K - is the number of repetitions. The drill is retracted and fed at a speed of G0, which can be limited by parameters # 78 and # 79.	G83 X10 Y5 Z-7 R0 Q1,4 I0 K1 F300	Drills the hole at point X10 Y5, from 0 to 7mm, at a speed of 300 mm / min. The step size is 1.4mm, thus 5 steps are done. Failure = 0, in this way the drill is returned on fast feed to the end point of the previous step.G80

Command	Options	Description	Example of use	Description of the example
G74	X Y Z R M	Tapping of right hand threads to be done with M3 spindle rotation.	M03 M8 (Speed & Feedrate) S400 F20 (Tapping) Z1.0	we want to tap a 1/4-20 thread 0.500" deep at 0, 0. Here's the code to do that with G84 G Code.
G84	X Y Z R M	Tapping of right hand threads to be done with M3 spindle rotation.	G00 X0.0 Y0.0 G01 M29 G84 Z-0.5 R0.2	
G90	No	For G0/G1:Specifying absolute coordinates; For G2/G3:The main coordinates are absolute and the centers of the arcs are relative.	G90 G1 X10 Y0 G90 G2 X20 I5	
G91	No	For G0/G1:Specifying relative coordinates; For G2/G3:The main coordinates are relative and the centers of the arcs are relative.	G90 G1 X10 Y0 G91 G2 X10 I5 G2 X-10 I-5	
G90.1	No	For G0/G1:Specifying absolute coordinates; For G2/G3:The main coordinates are absolute and the centers of the arcs are absolute.	G90 G1 X10 Y0 G90.1 G2 X20 I15 G2 X10 I15	
G91.1	No	For G0/G1:Specifying relative coordinates; For G2/G3:The main coordinates are relative and the centers of the arcs are absolute.	G90 G1 X10 Y0 G90.1 G2 X20 I15 G2 X10 I15	
G92	X Y Z A	Setting new current coordinates	G90G92X0Y0Z0A0	Zero all axes
G98	No	After drilling cycles, the tool returns to the Z position, before the start of the cycle. Raises the Z axis to a safe height..	G98 ----- G1 Z1 F1000 ----- G81 X0 Y0 Z-7 R0 K1 F300	After drilling, the tool will be in position 1 to Z
G99	No	After the drilling cycles, the tool returns to the point R (along the Z axis). Raises the Z axis to a safe height.	G99 ----- G1 Z1 F1000 ----- G81 X0 Y0 Z-7 R0 K1 F300	After drilling, the tool will be in position 0 to Z

Command	Options	Description	Example of use	Description of the example
M0, M00	No	Stopping the program, before pressing the "START" button, is completely the same as pressing the "PAUSE" button.	M0	Stops the program, before pressing the "START" button. Raises the Z axis and sets the spindle, if it is set in the settings.
M01	No	Optional Stop: Operator Selected to Enable	M01	Stops the machine unless there is further interaction from the User.
M3, M03	S	Start spindle rotation with speed S	M3 S2000	Starts the spindle at a speed of 2000 rpm
M4, M04	S	Start spindle rotation with speed S in CCW direction	M4 S2000	Starts the spindle at a speed of 2000 rpm in CCW
M5, M05		Stop the spindle	M5	Stops the spindle
M6, M06	T	Plays the contents of the T.nc. file Specifies the tool number for offsets. T specifies the number of the tool (it can be omitted).	M6 T5	Replaces the tool with T5
M8, M08	No	Switch on spindle cooling	M8	Switch on spindle cooling
M9, M09	No	Switch off spindle cooling	M9	Switch off spindle cooling
M10	No	Turn on the coolant pump	M10	Turn on the coolant pump
M11	No	Turn off the coolant pump	M11	Turn off the coolant pump
M30	No	End of the program, cancels all commands and loops. Do not use immediately after M6.	M110	It stops the program, before pressing the "START" button. Peep 3 times with built-in peepal
M47	No	Repeat program from first line.	M47	Restart Program Execution
M50 / M51		Output 01 Open / Close		Control the Output 01
M52 / M53		Output 02 Open / Close		Control the Output 02
M54 / M55		Output 03 Open / Close		Control the Output 03
M56 / M57		Output 04 Open / Close		Control the Output 04
M58 / M59		Output 05 Open / Close		Control the Output 05
M60 / M61		Output 06 Open / Close		Control the Output 06
M62 / M63		Output 07 Open / Close		Control the Output 07
M64 / M65		Output 08 Open / Close		Control the Output 08
M66 / M67		Output 09 Open / Close		Control the Output 09
M68 / M69		Output 10 Open / Close		Control the Output 10
M70 / M71		Output 11 Open / Close		Control the Output 11
M72 / M73		Output 12 Open / Close		Control the Output 12
M744 / M75		Output 13 Open / Close		Control the Output 13
M76 / M77		Output 14 Open / Close		Control the Output 14
M78 / M79		Output 15 Open / Close		Control the Output 15
M80 / M81		Output 16 Open / Close		Control the Output 16
M82 / M83		Output 17 Open / Close		Control the Output 17
M84 / M85		Output 18 Open / Close		Control the Output 18
M86 / M87		Output 19 Open / Close		Control the Output 19
M88 / M89		Output 20 Open / Close		Control the Output 20
M90 / M91		Output 21 Open / Close		Control the Output 21

Command	Options	Description	Example of use	Description of the example
M98		Call a Subprogram with the reference to the separate program created and loaded on the controller.	M98 Pxxxx Ln	xxxx is the line number, nn is the number of repetitions
M99		End Sub-Program or Return or Loop	O01234 ... (Part program) ... M98 P111 (Jumps to program O00111 to run) ... (The M99 at the end of the sub-program will jump back here) ... (Finish part) M30 (End of main program)	This M-code is used to end the sub-program. If M99 is used in the main program, it will cause the program to loop back to the beginning and repeat over and over again without stopping.
F	No Application	Sets the speed of the working feed, for many commands. You can write, as at the end of the line with the command, and a separate line. If F is not specified anywhere, the speed from parameter #76 is used.	F100 ----- G1X10.5	Moves the X axis to, at point 10.5, at a speed of 100.
P	No Application	Specifies the pause time, in milliseconds, for the G4 and G82 commands. You can write, as at the end of the line with the command, and a separate line.	P2000 ----- G4	Pauses the program for 2 seconds
S	No Application	Specifies the spindle speed for the M3 command. You can write, as at the end of the line with the command, and a separate line.	S21000 ----- M3	Starts the spindle at a speed of 21000 rpm
■	No Application	The symbol for dividing the whole and fractional parts of numbers. Comma - does not work.	G0 X10.5	Moves the X axis on fast feed, to the point 10.5. Option G0 X10.5 - will not work.
SIN	[n]	The sine of the parameter n, in degrees.	#1=SIN[30.0]	
COS	[n]	The cosine of the parameter n, in degrees.	#1=COS[60.0]	
TAN	[n]	The tangent of the parameter n, in degrees.	#1=TAN[45.0]	
SQRT	[n]	The square root of the parameter n.	#1=SQRT[2.0]	
ATAN	[n1,n2]	returns the angle between the ray to the point (n1,n2) and the positive x-axis, confined to (-180, 180].	#1=ATAN[30,10]	
ABS	[n]	returns the absolute value of that parameter n.	#1=ABS[-30.1]	